

INSTALLASJONSVEILEDNING

Vikingbad Liam Buet Dusjdør

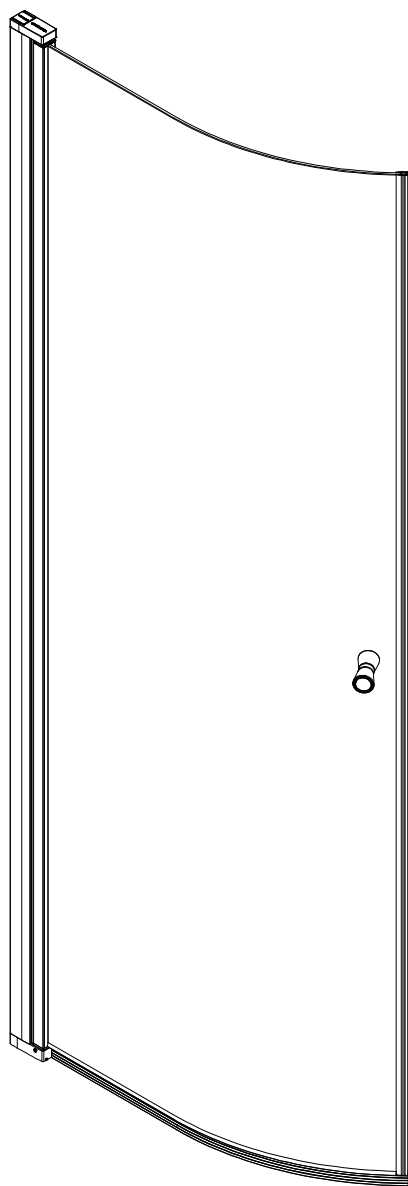

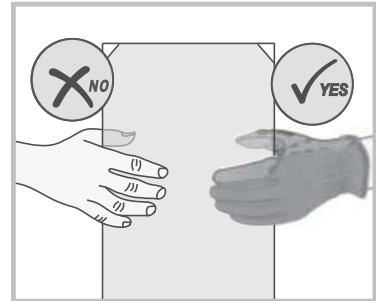
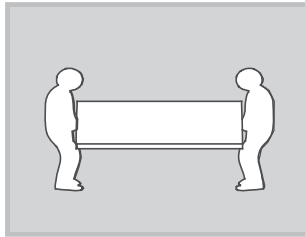
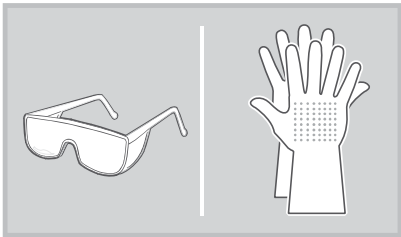
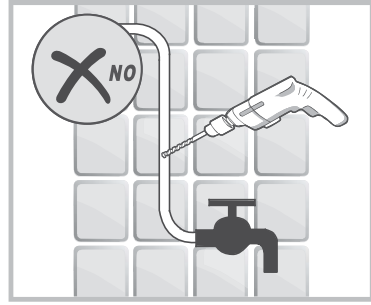
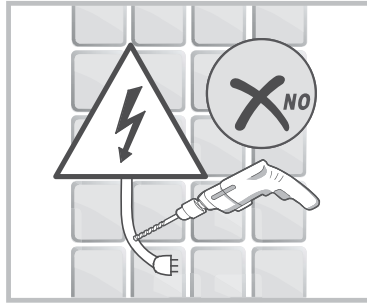
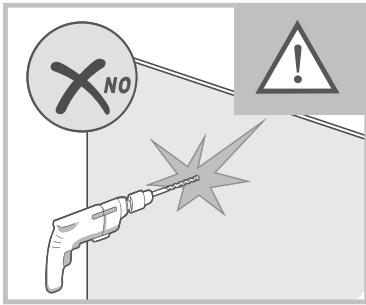

Liam dusjdør skal monteres på ett fast underlag og kan ikke henges på vegg uten understøttet bunn hengsle.

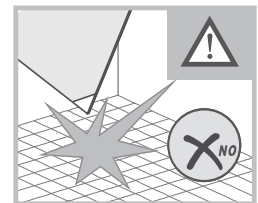
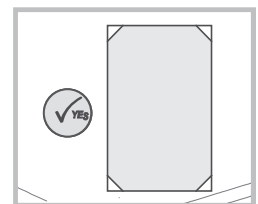
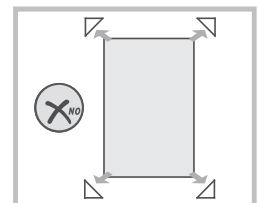
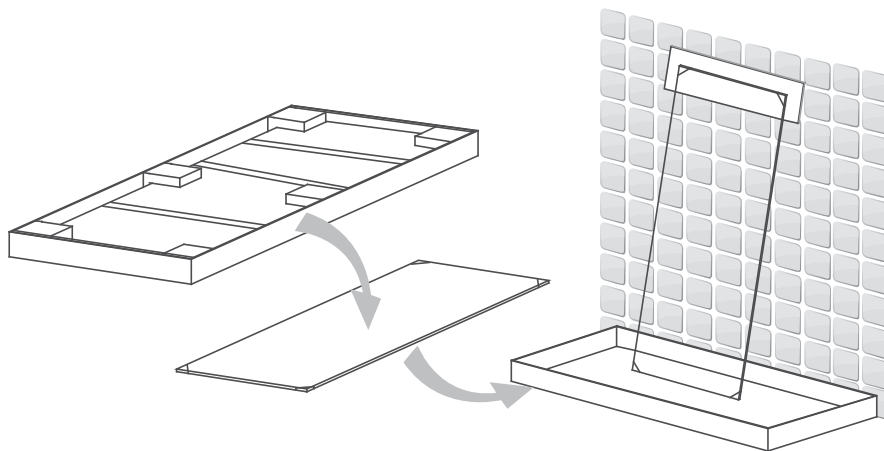
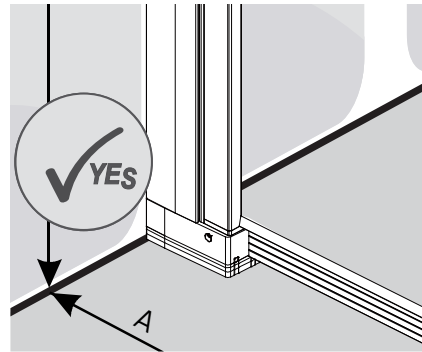
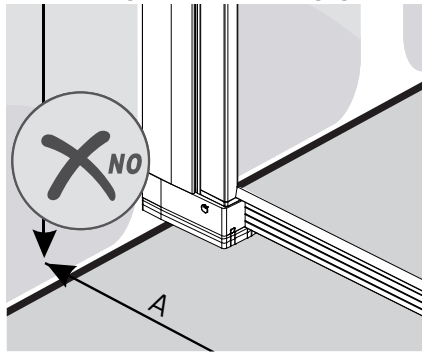

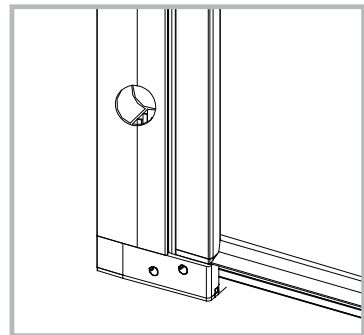
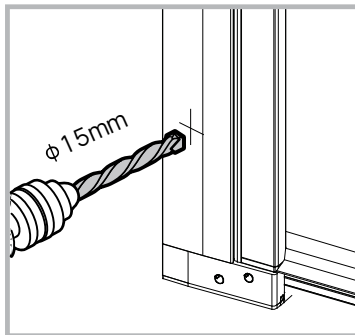
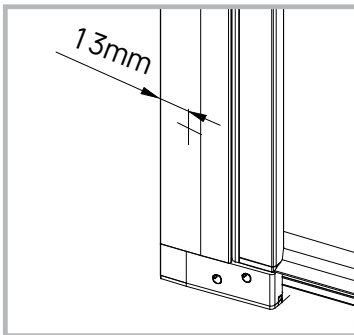
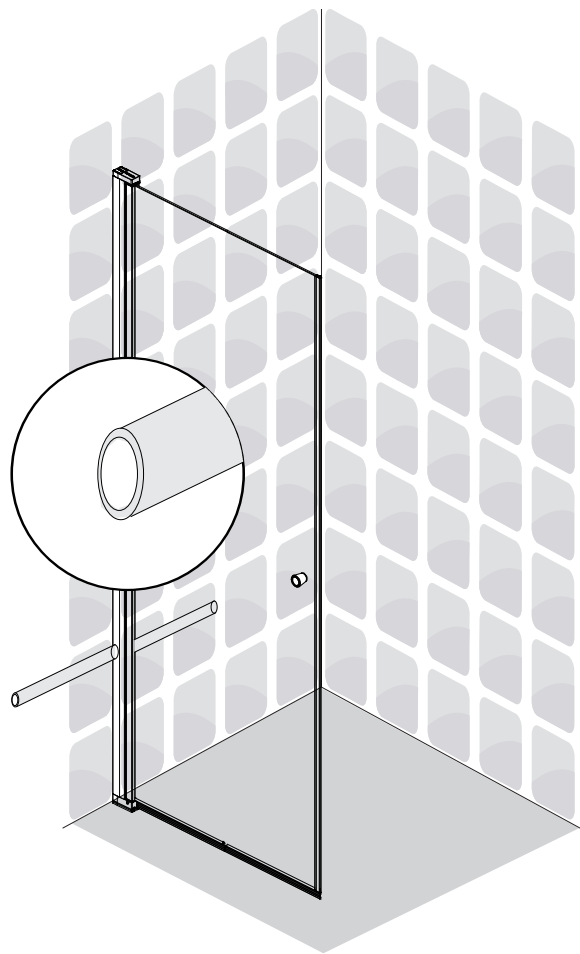

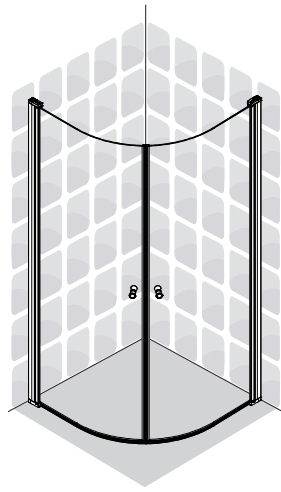

A

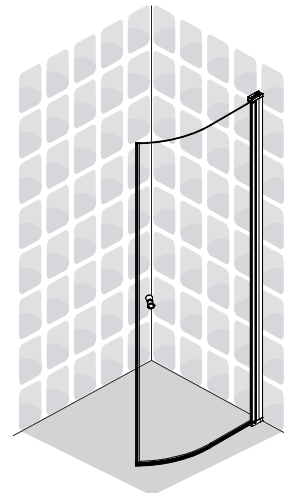
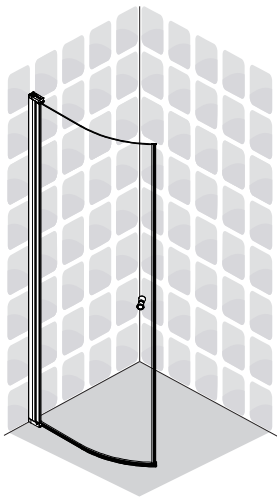

B

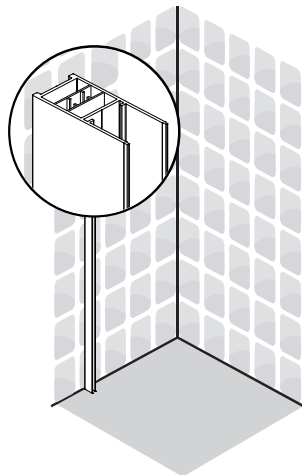

C

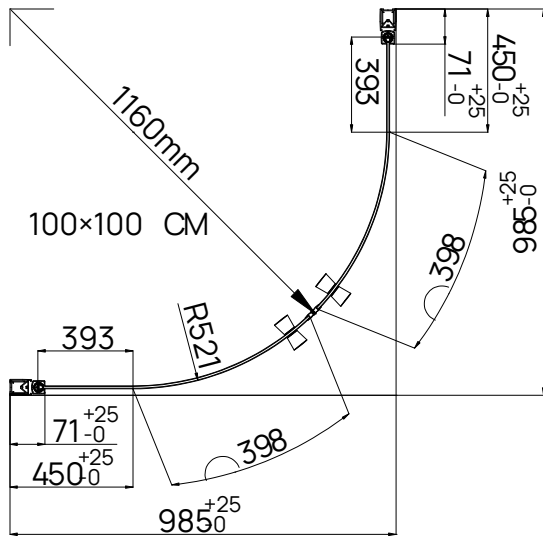
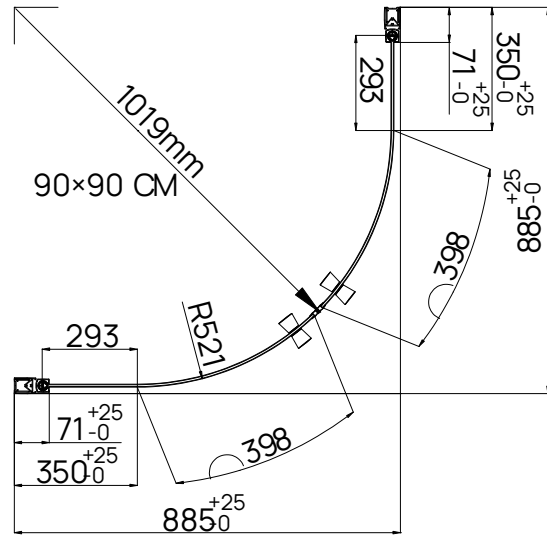
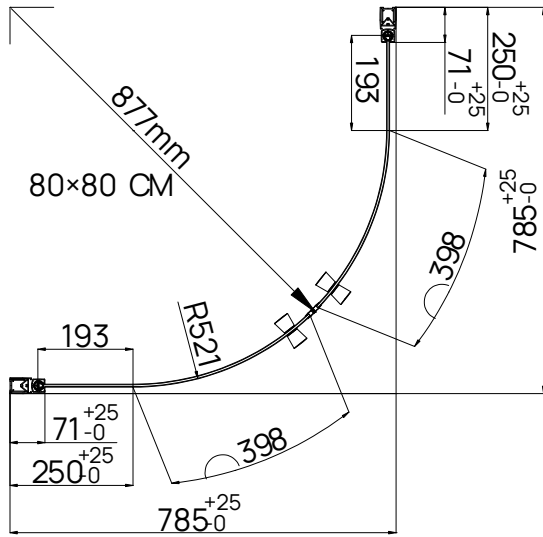

A

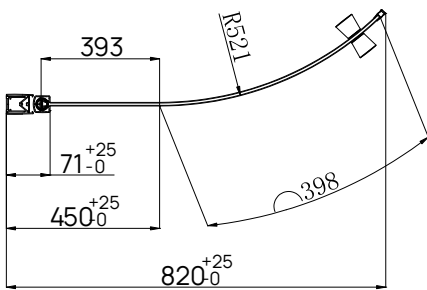
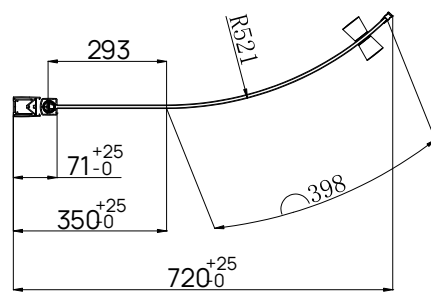
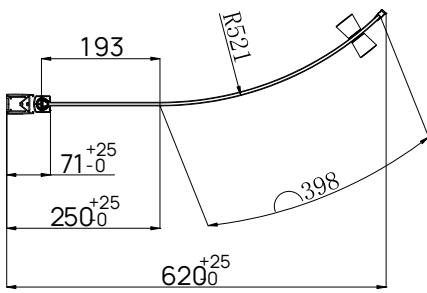

B

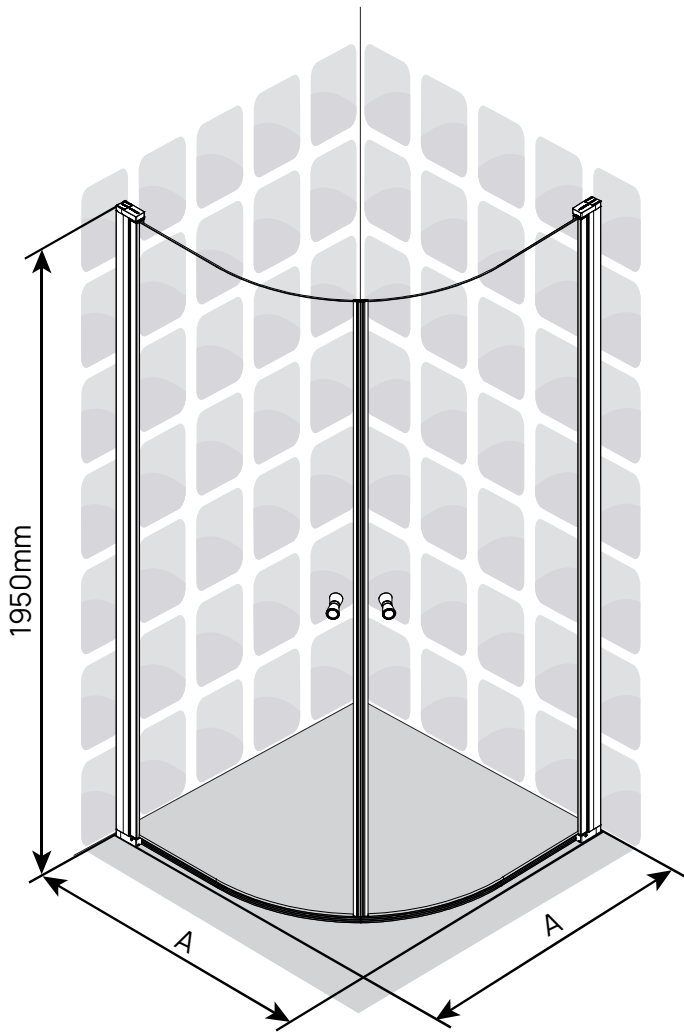
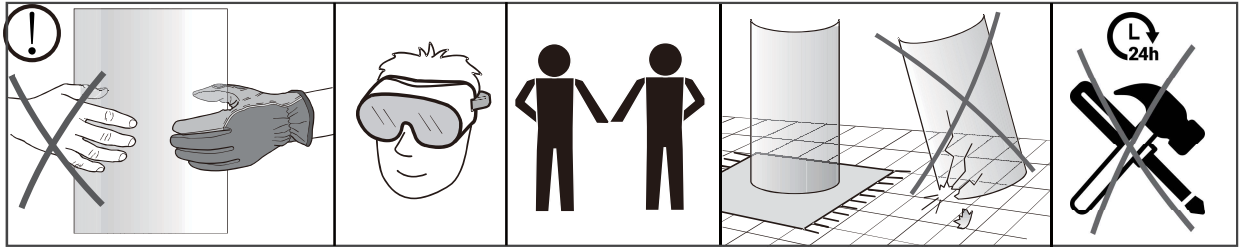

A	Min	Max
700	685	710
800	785	810
900	885	910
1000	985	1010

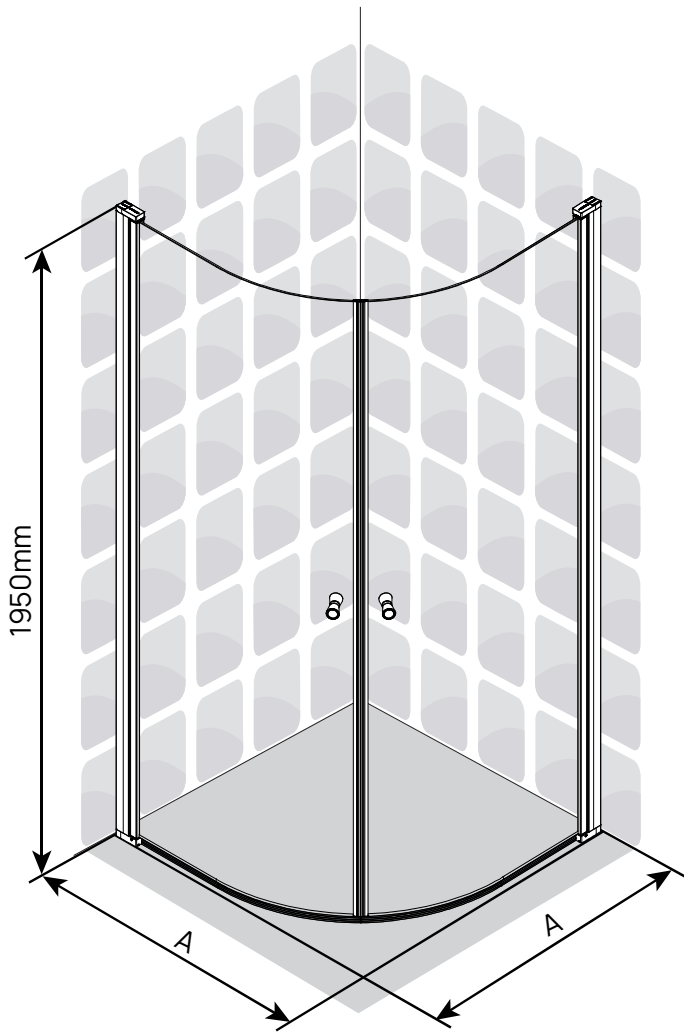
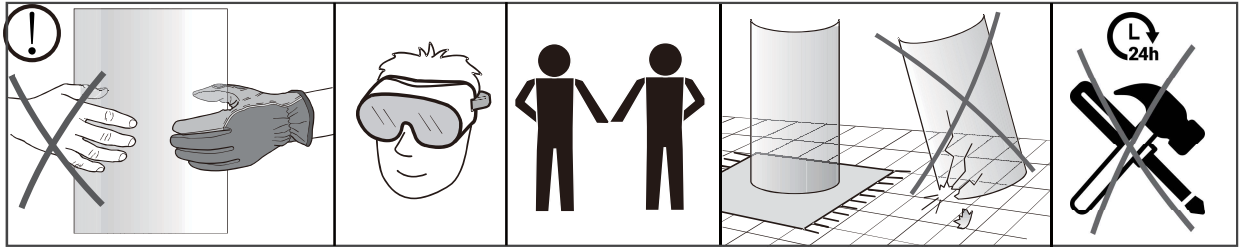

A	Min	Max
700	685	710
800	785	810
900	885	910
1000	985	1010

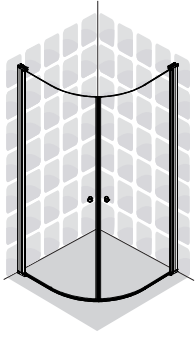

CTN1/2

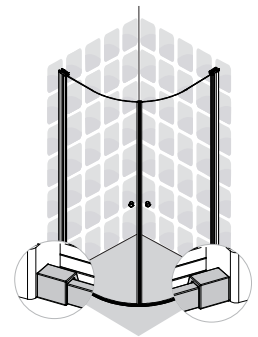
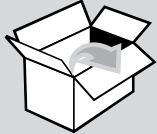

CTN1/2/3

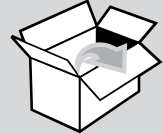

CTN1

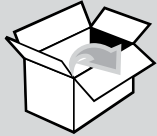

CTN2

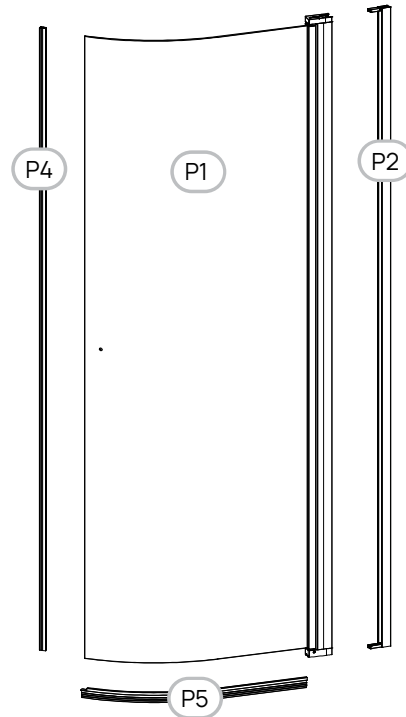
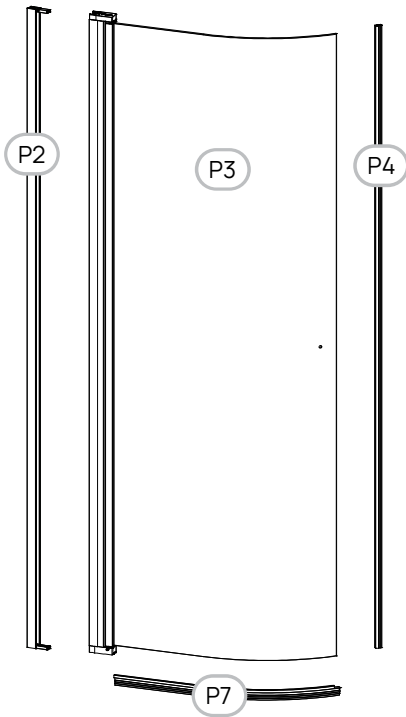
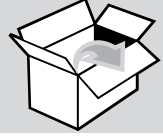

CTN3

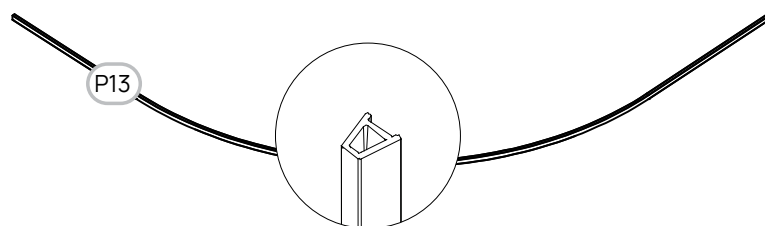
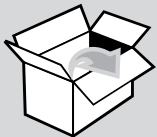

CTN1/2

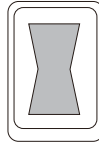
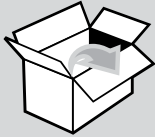

1

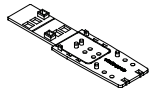

2mm

x1

2

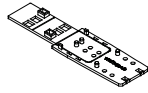

3mm

x1

3

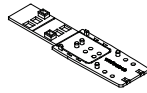

4mm

x1

4

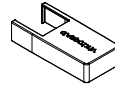

x1

5



x4

6



x4

7



x4

8



x4+2

9



x1

10

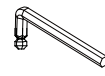

2.5mm

x1

11

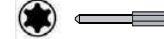

x1

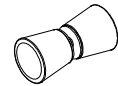

x1

CTN3

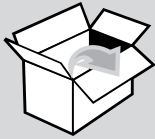

x1



x1

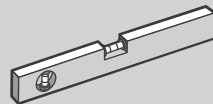
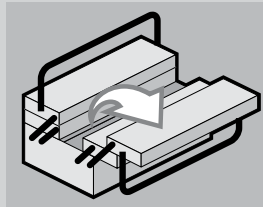

Ø6mm

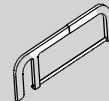
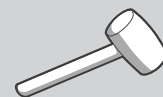
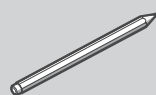
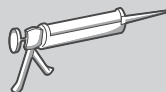

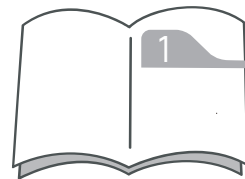
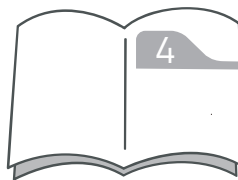
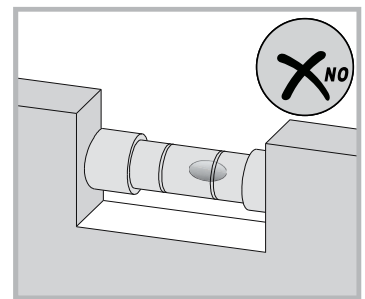
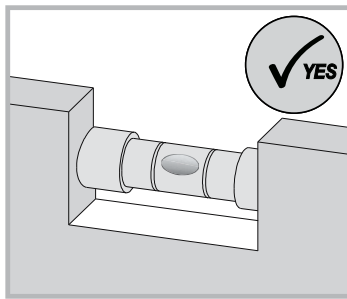
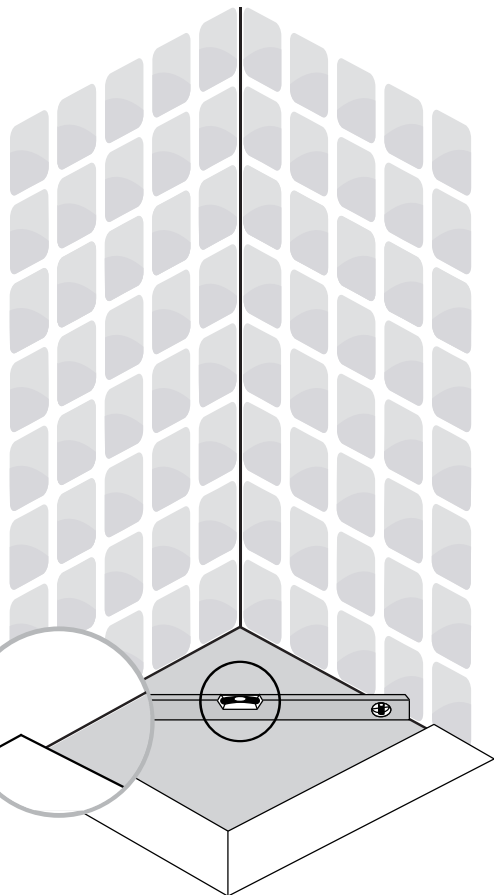
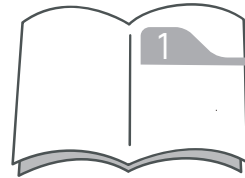
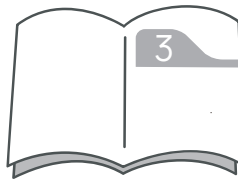
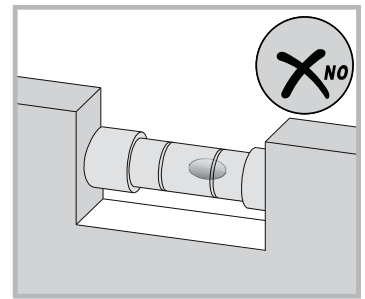
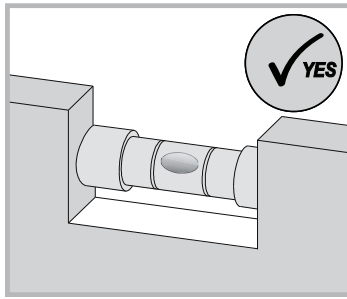
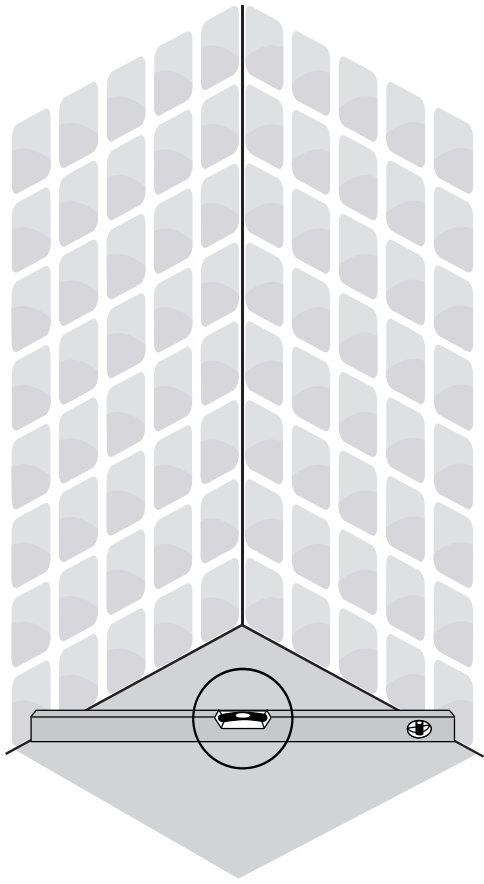

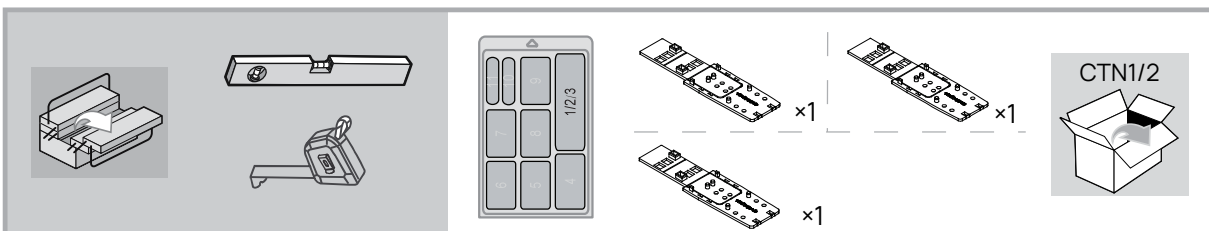
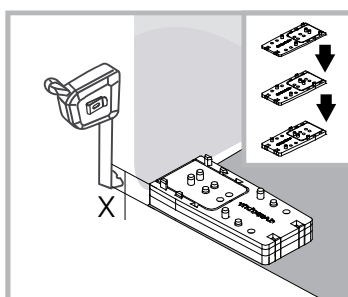
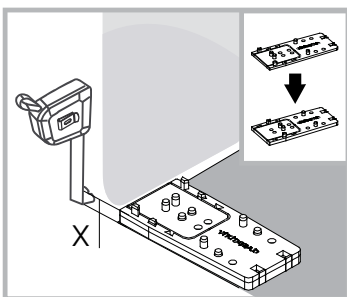
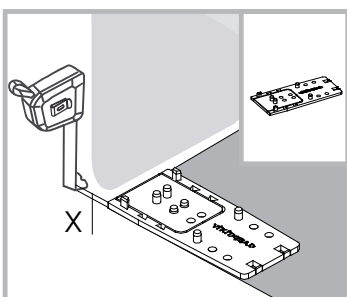
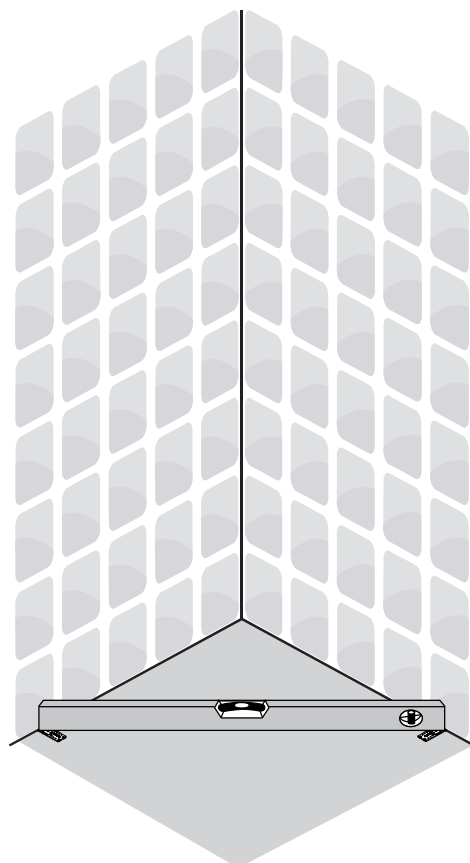
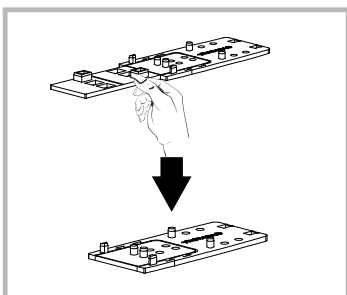
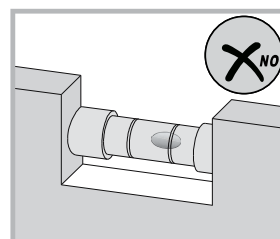
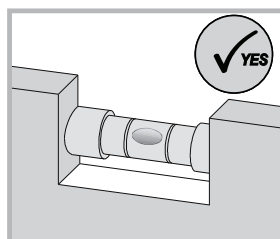
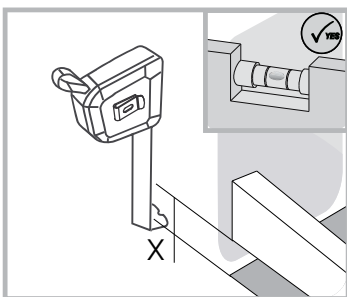

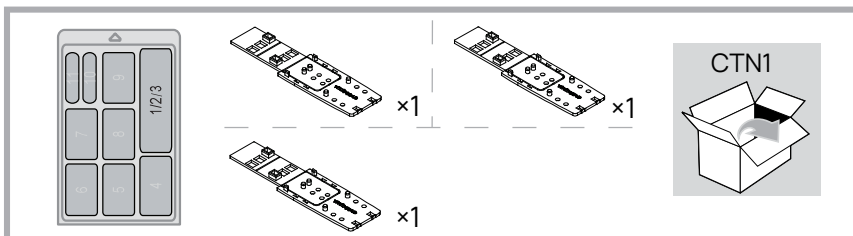
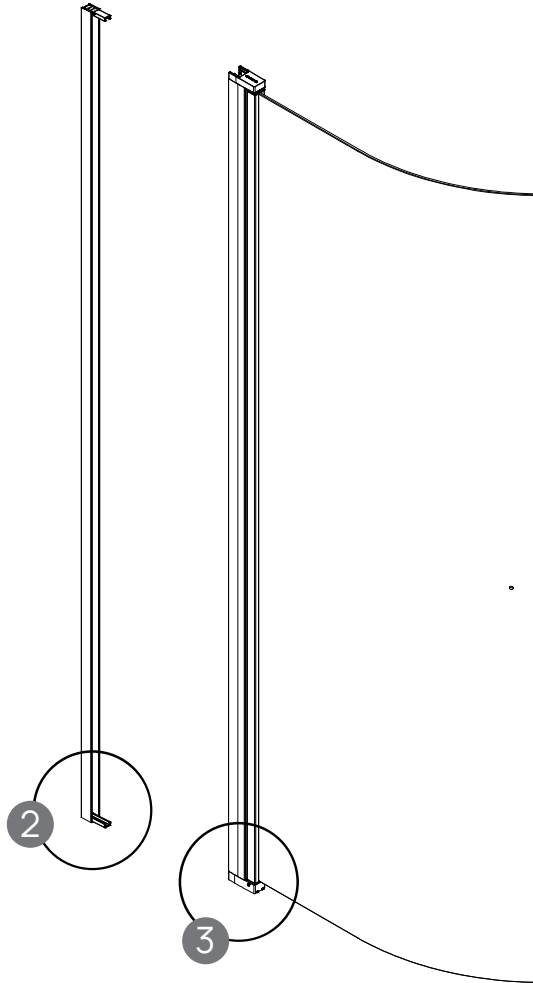
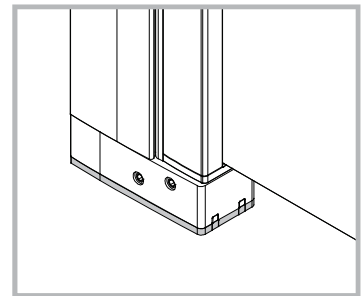
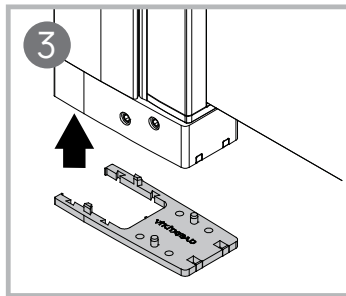
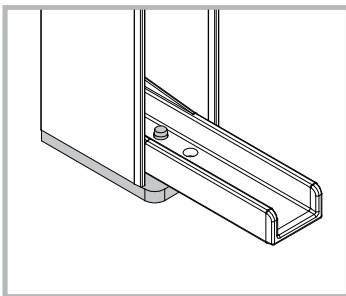
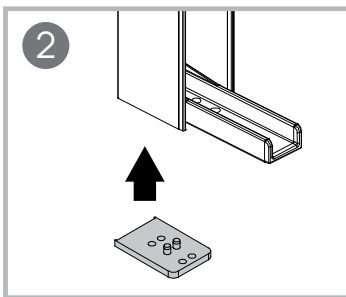
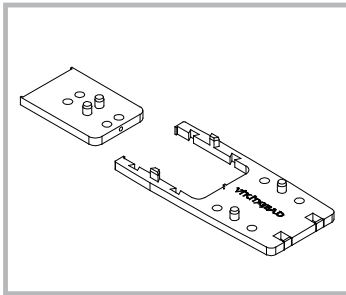
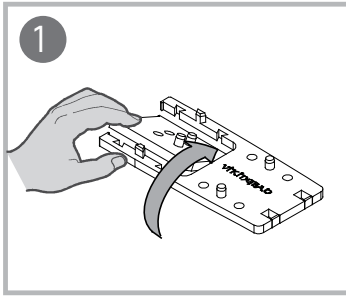

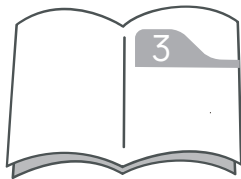
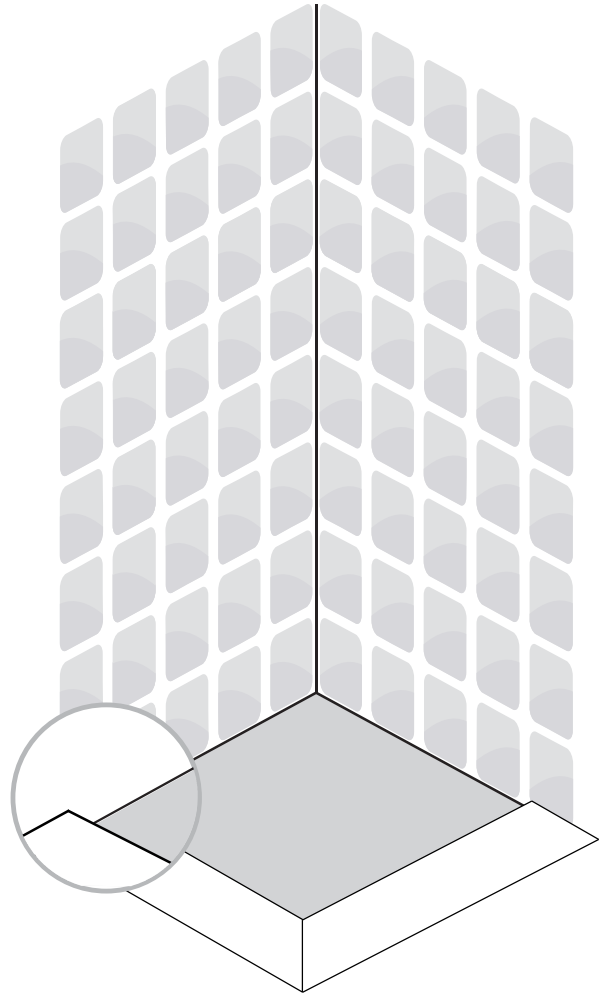
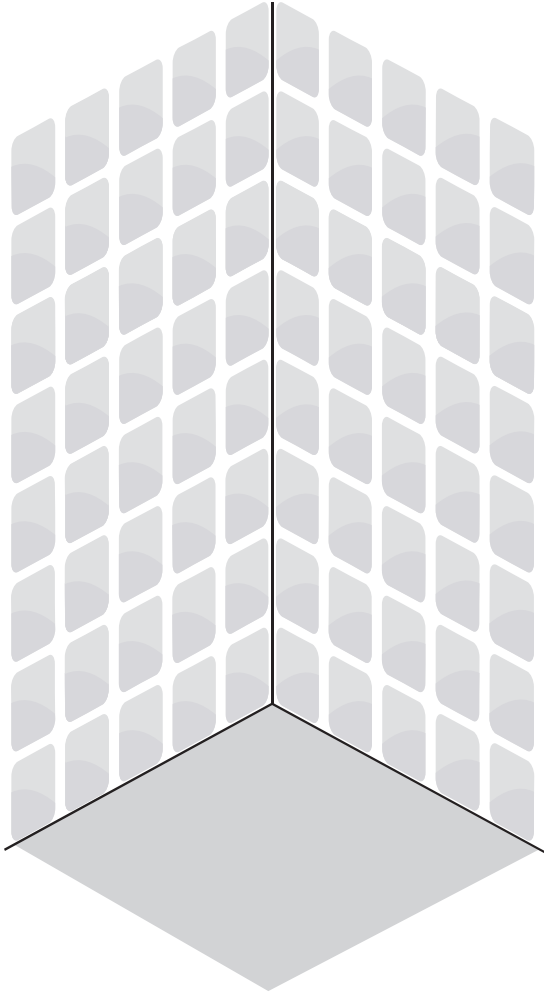

3

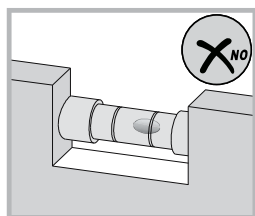
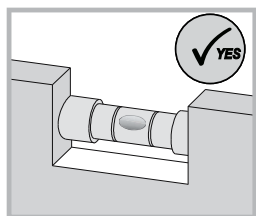

A	Yttemål ferdigmontert		Yttemål veggprofil	
	Min	Max	Min	Max
700	685	710	681	706
800	785	810	781	806
900	885	910	881	906
1000	985	1010	981	1006

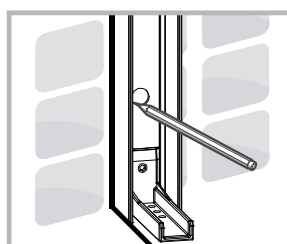
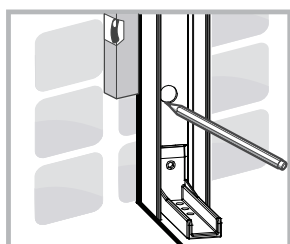
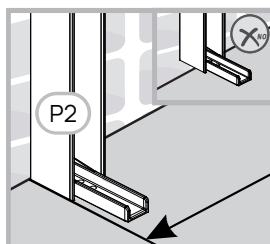
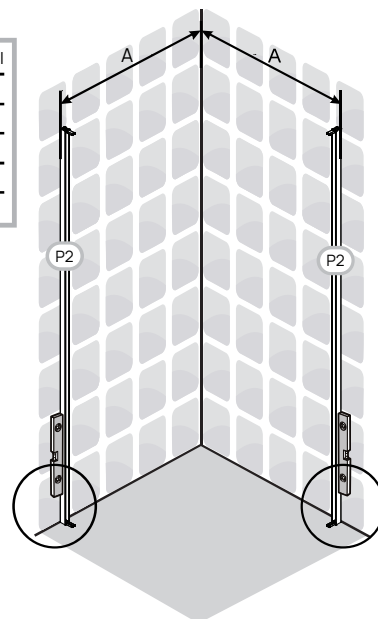

P2 $\times 2$

CTN1/2

5

4

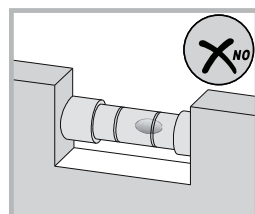
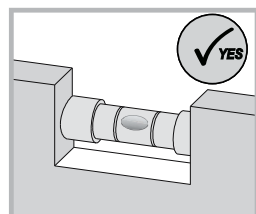

A	Yttemål ferdigmontert		Yttemål veggprofil	
	Min	Max	Min	Max
700	685	710	681	706
800	785	810	781	806
900	885	910	881	906
1000	985	1010	981	1006

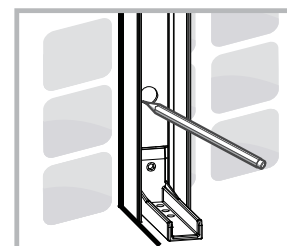
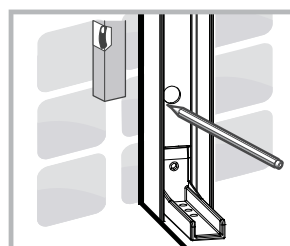
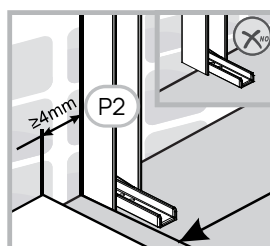
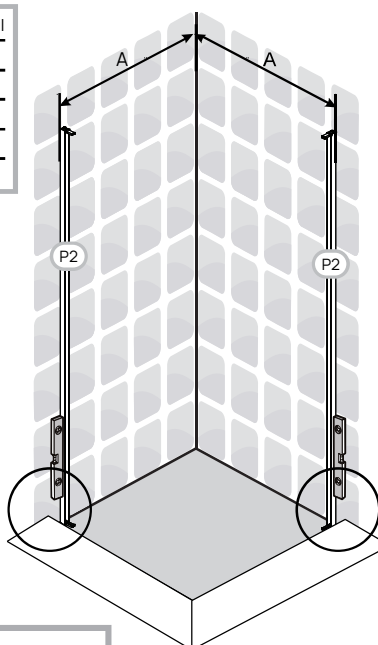

P2 $\times 2$

CTN1/2

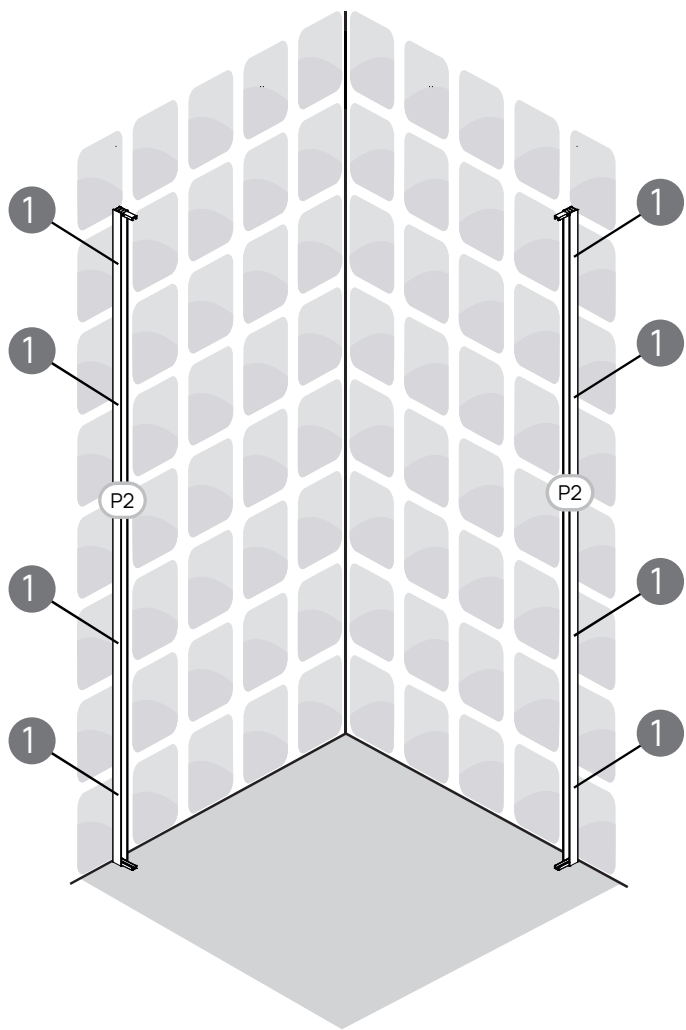
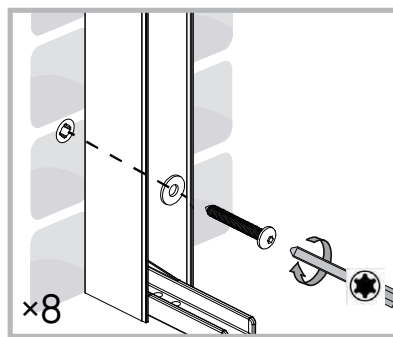
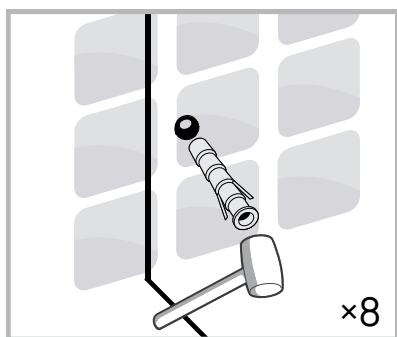
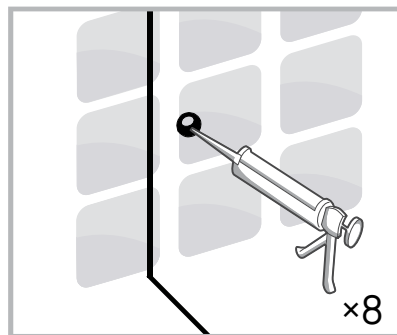
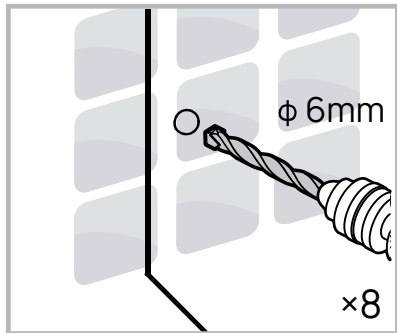

Tools: ϕ 6mm

Parts list:

- x8
- x8
- x8
- x1

CTN1/2

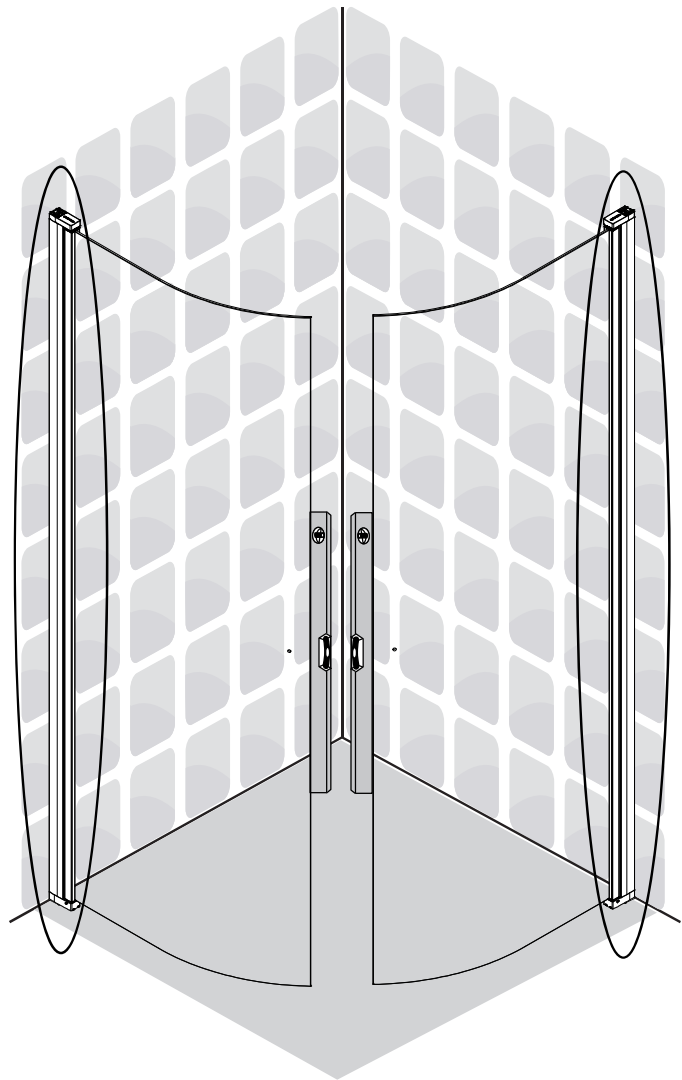
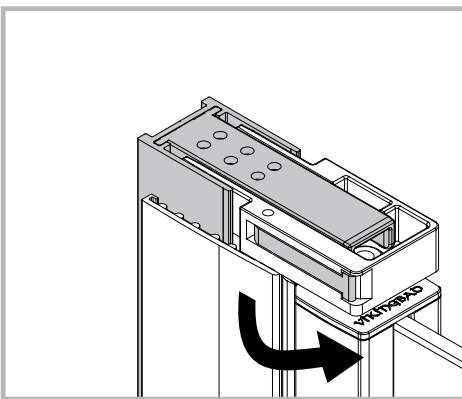
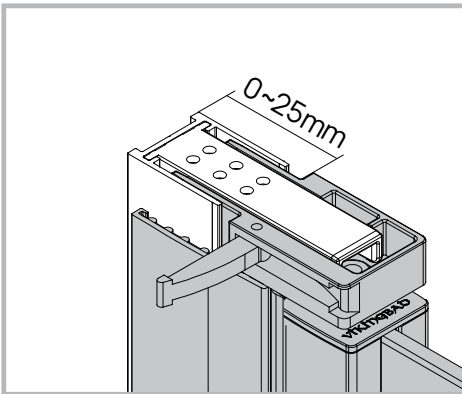
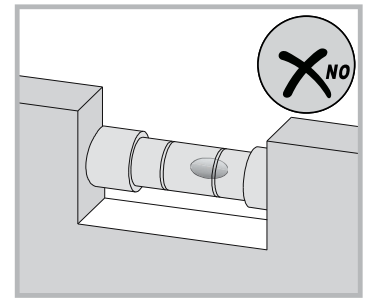
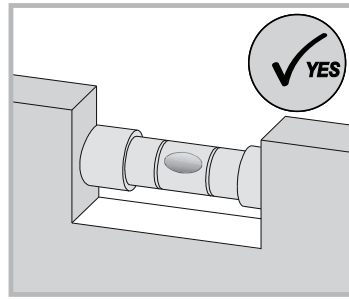
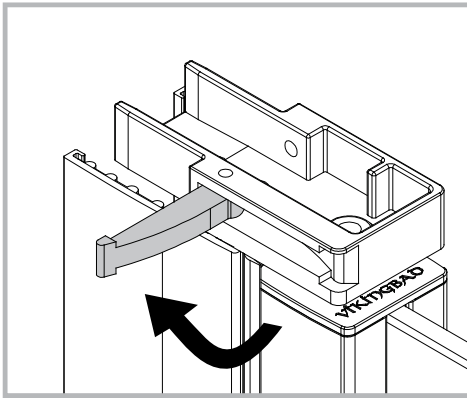

(P1)		x1	
(P3)		x1	

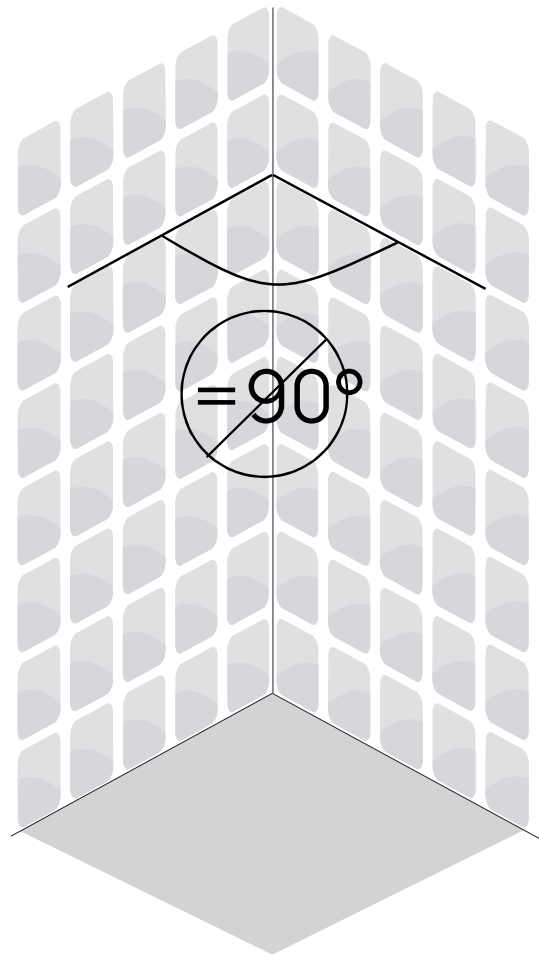
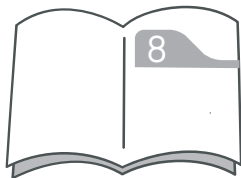
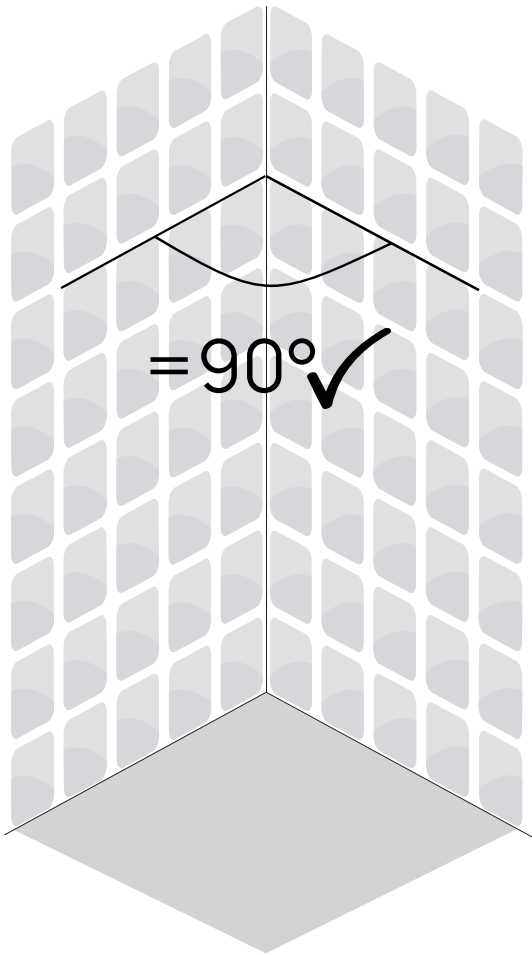

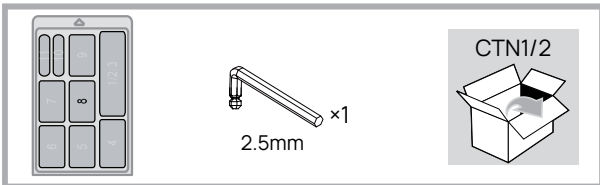
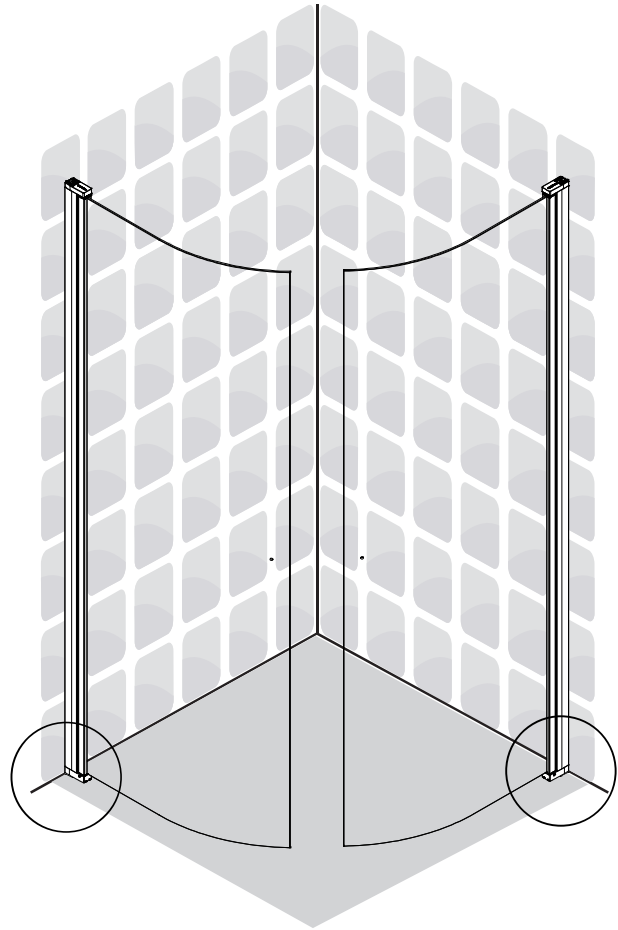
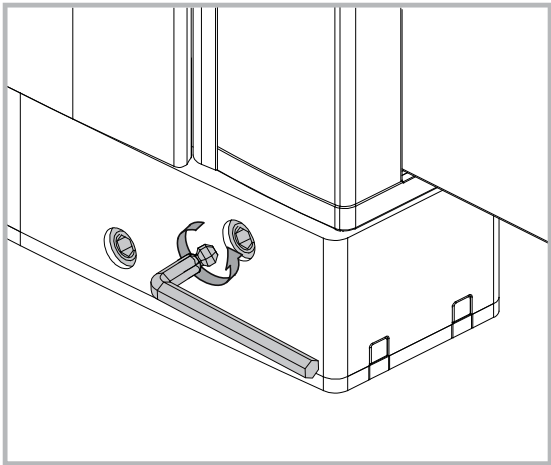
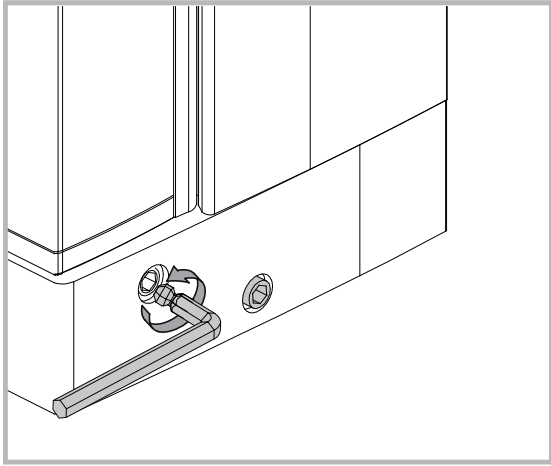

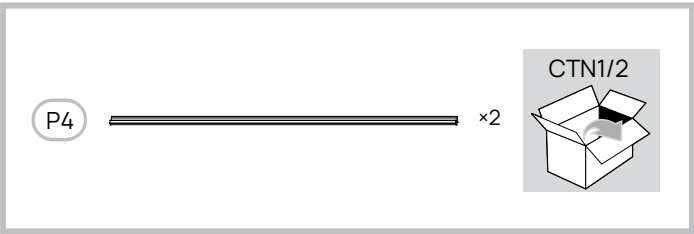
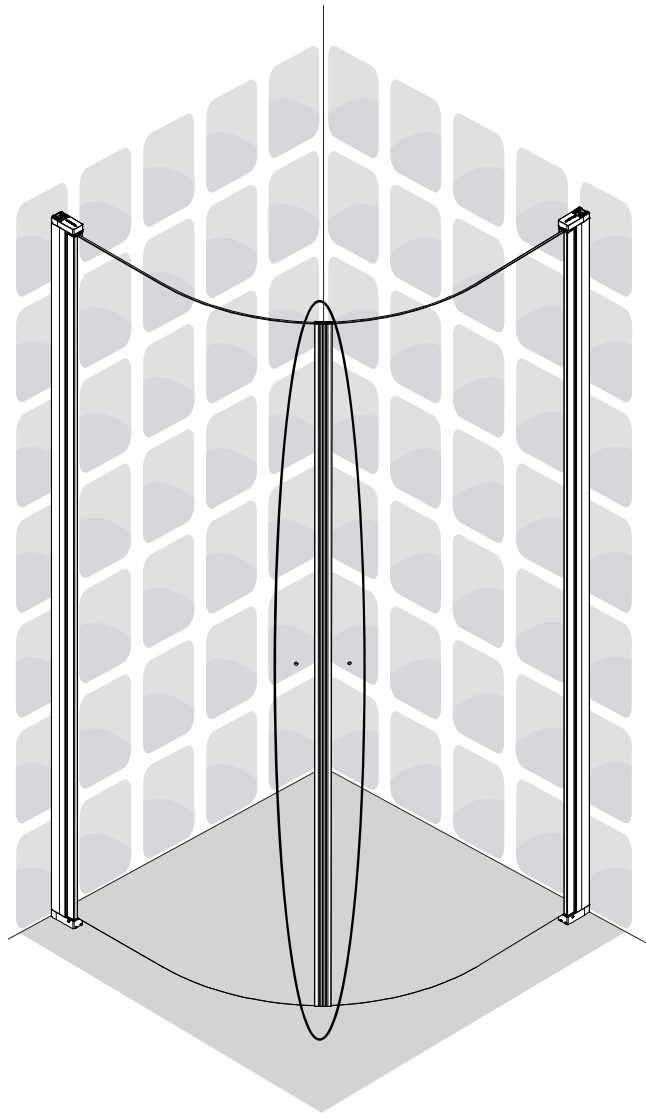
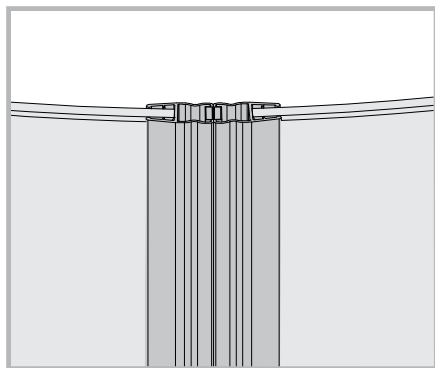
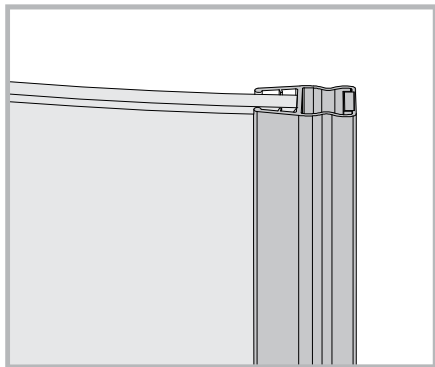
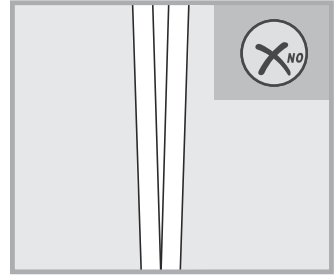
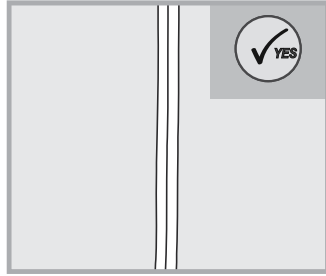
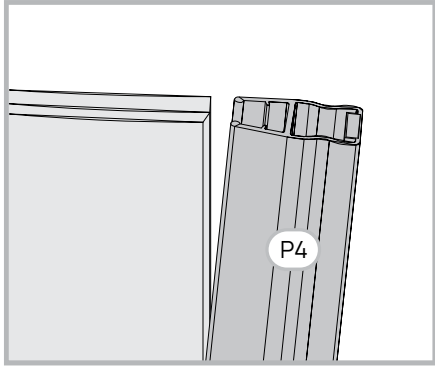

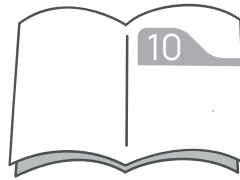
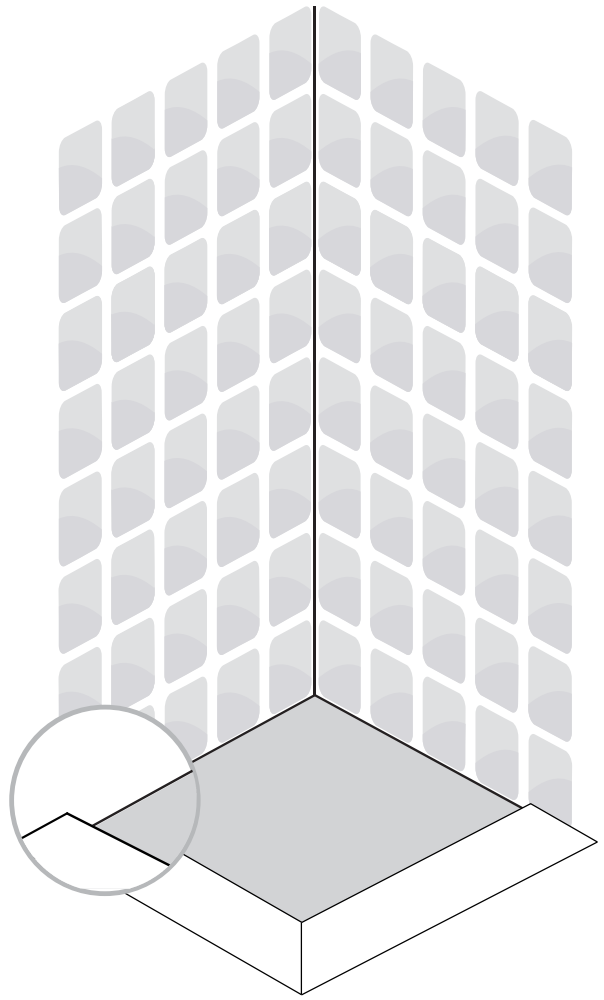
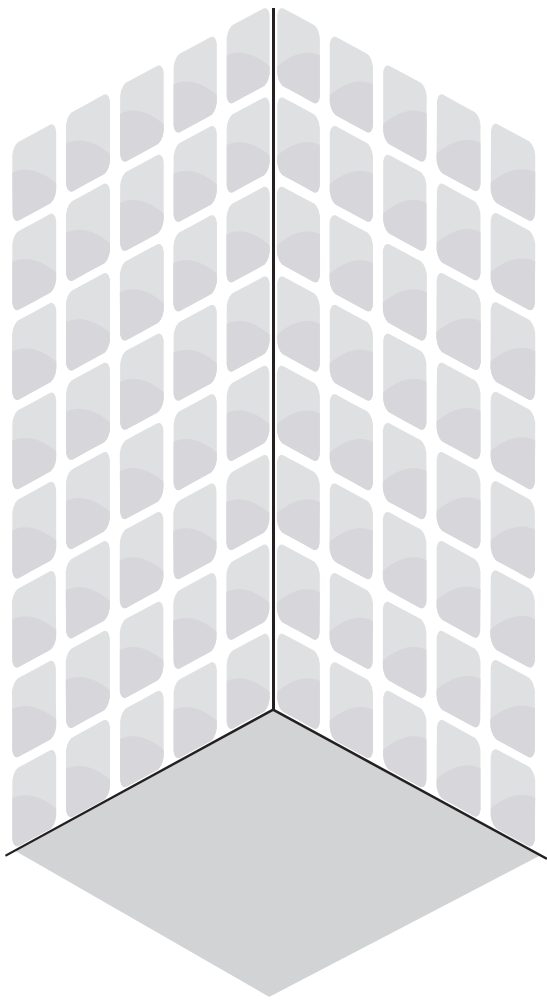

9

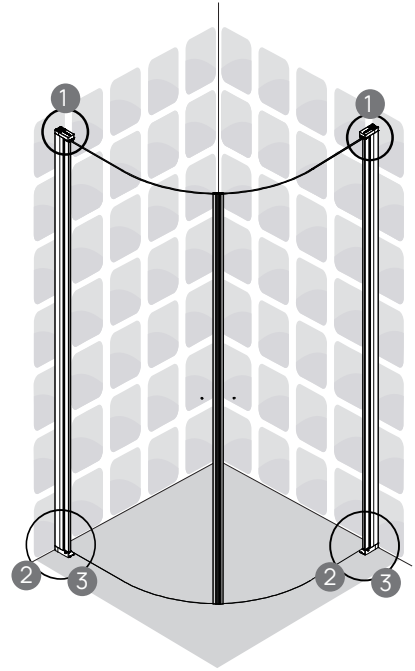
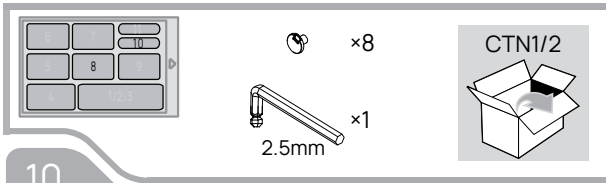
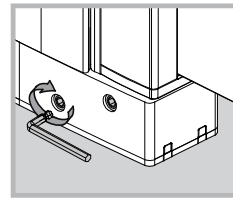
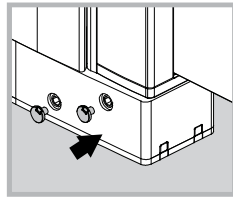
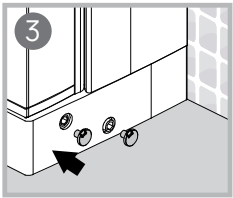
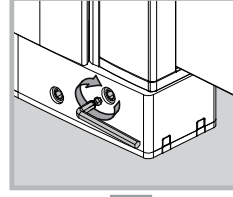
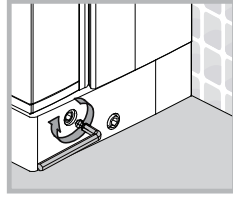
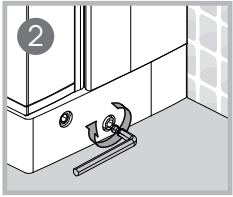
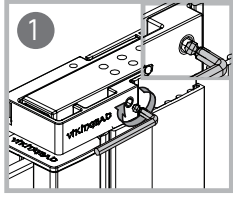

10

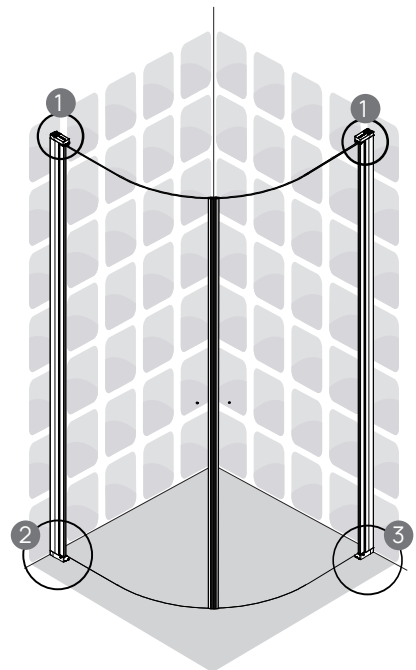
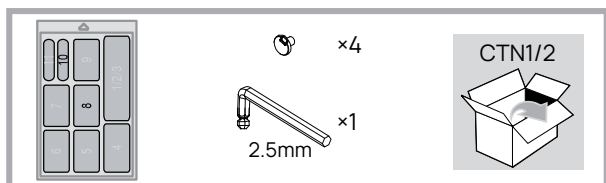
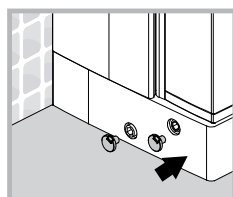
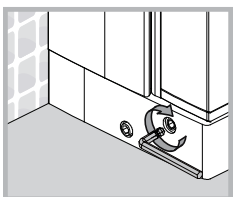
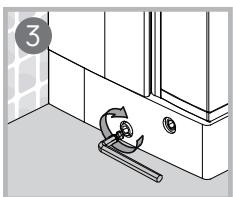
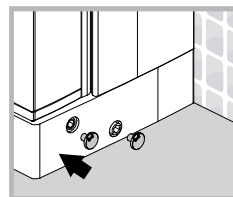
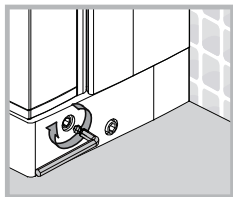
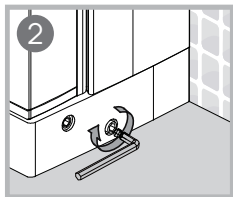
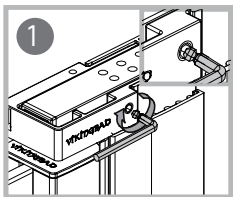

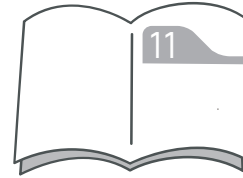
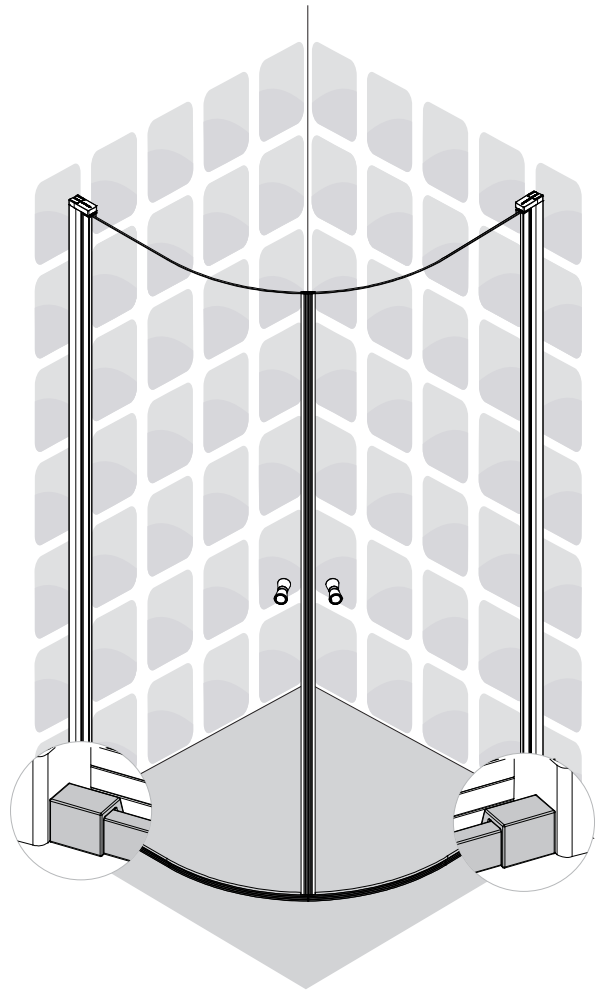
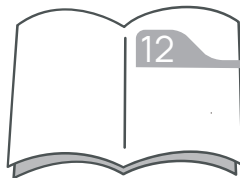
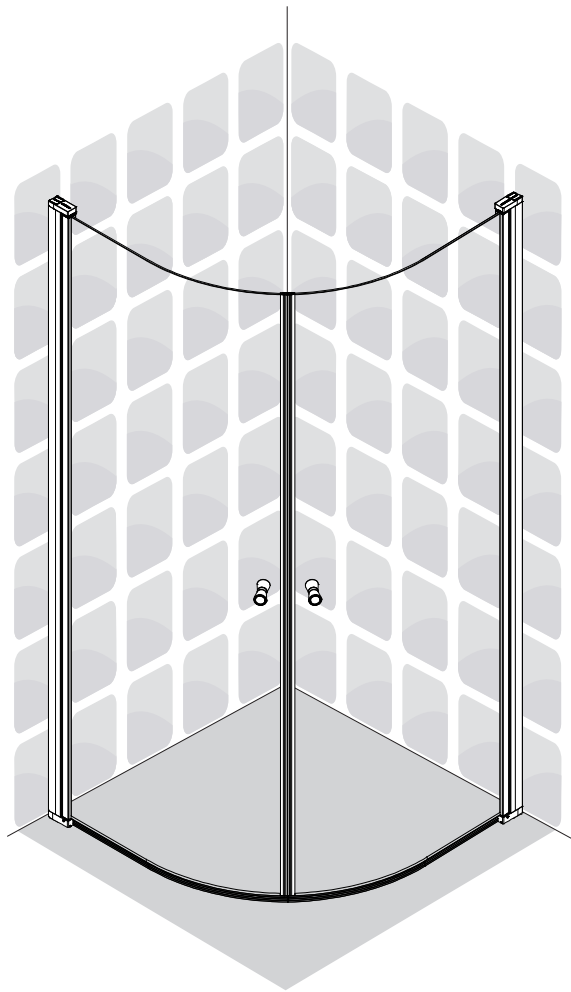

11

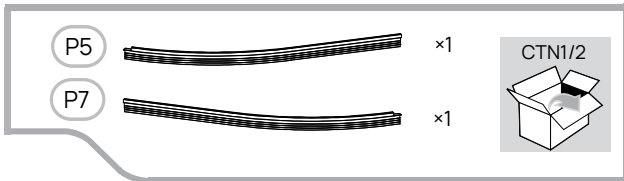
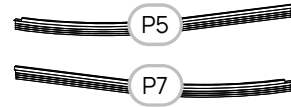
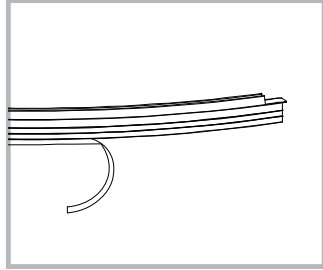
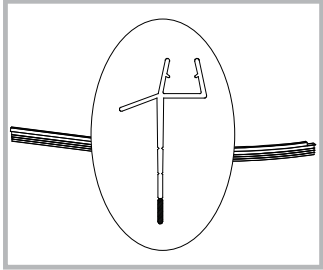

12

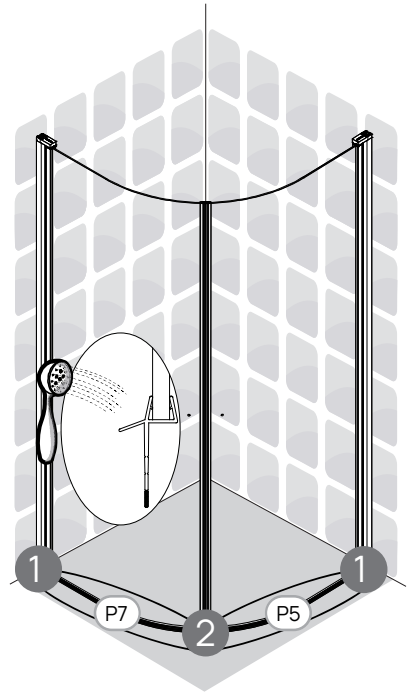
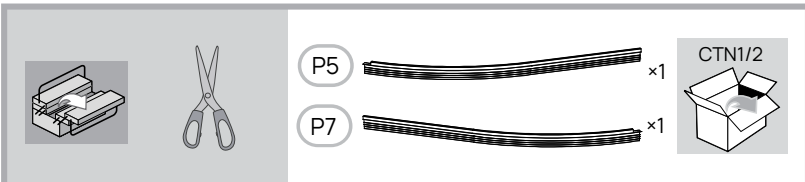
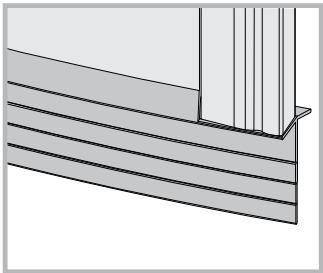
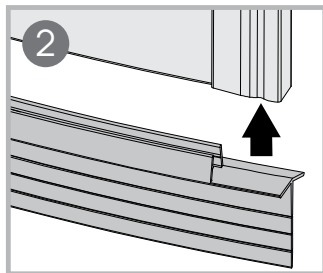
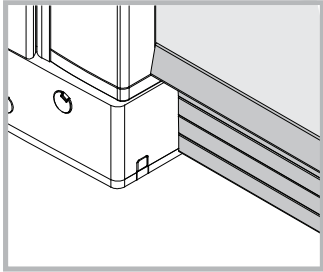
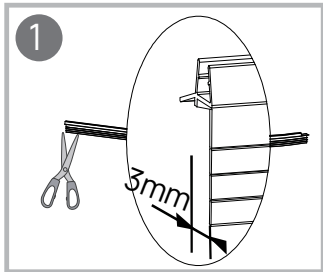

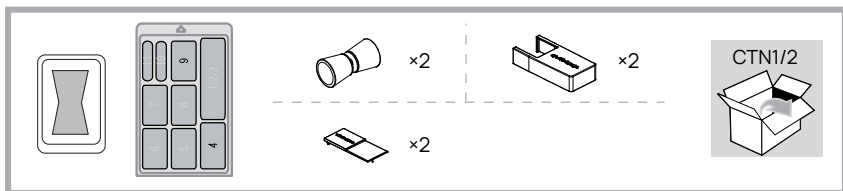
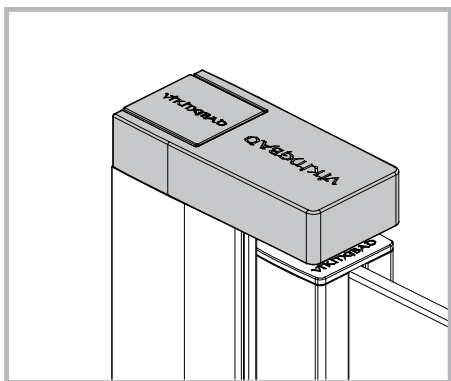
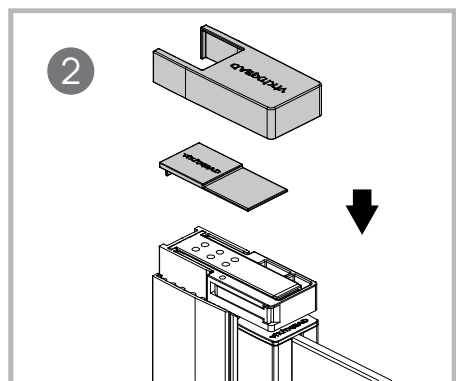
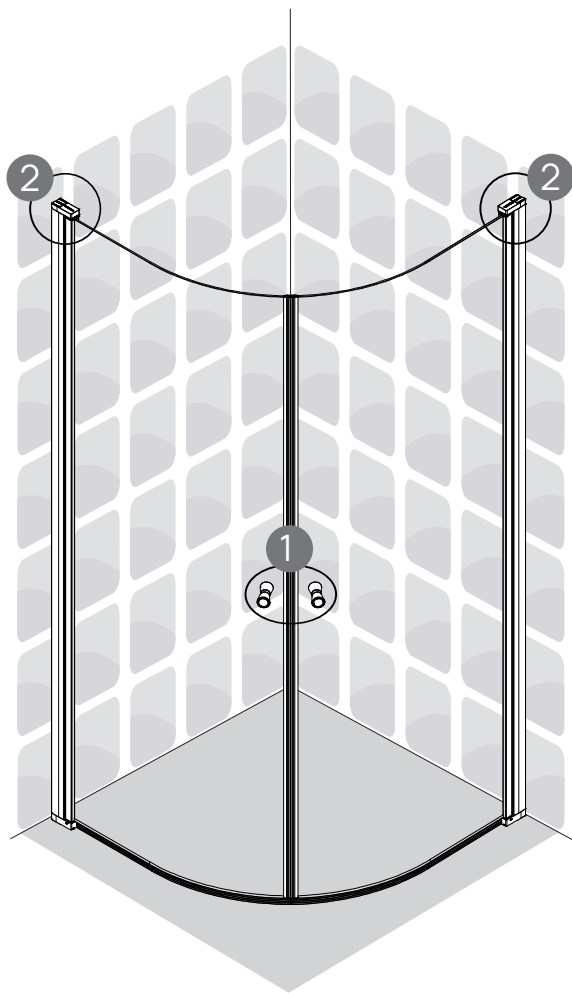
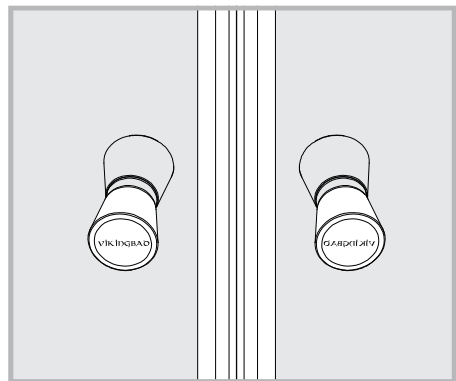
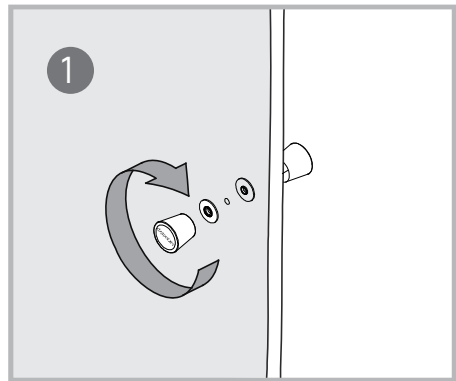

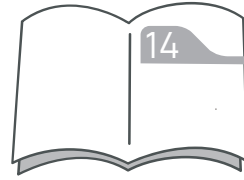
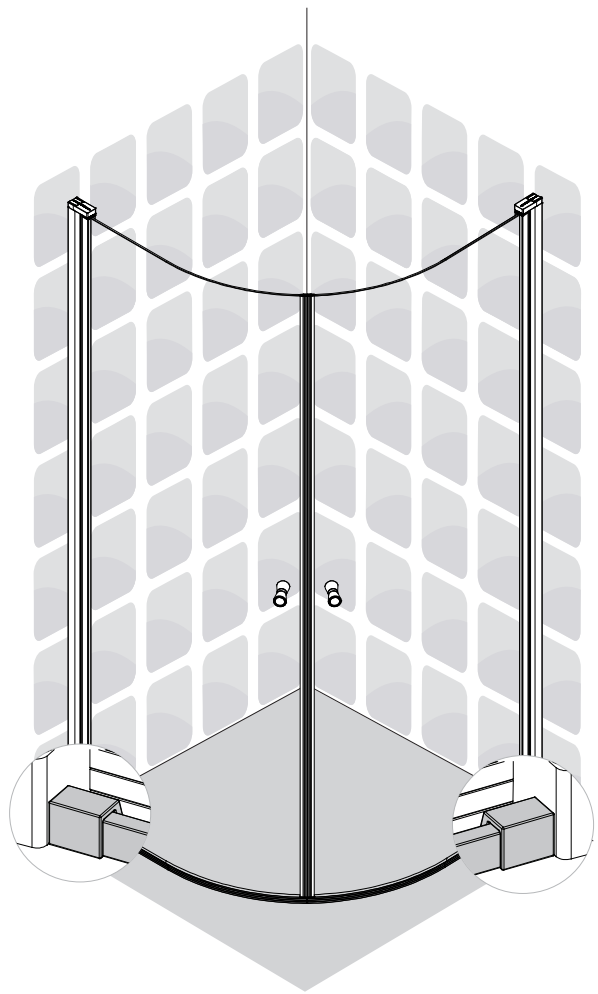
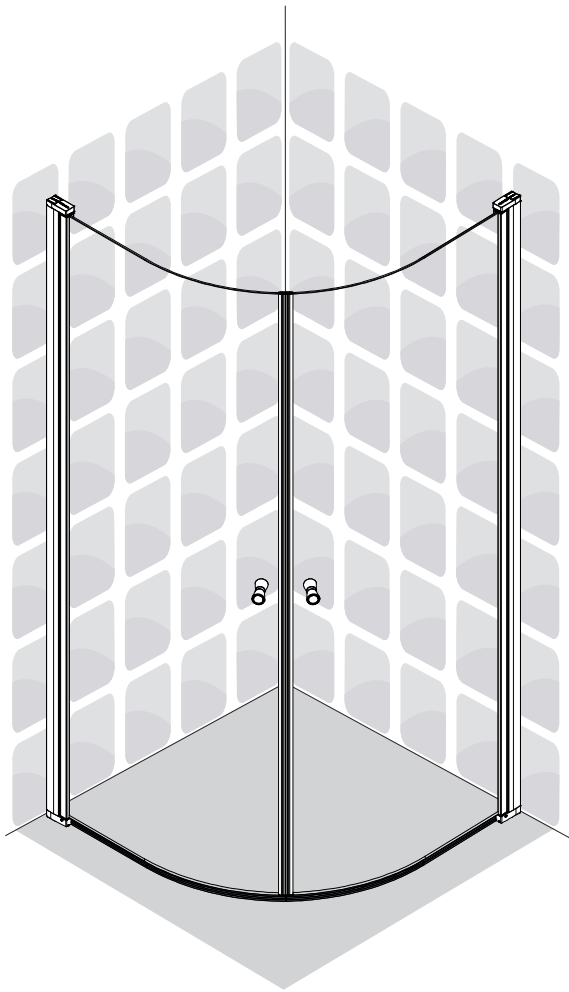

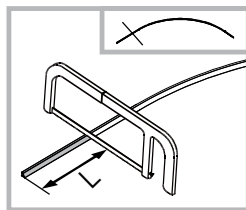
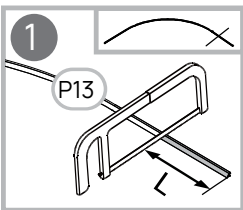
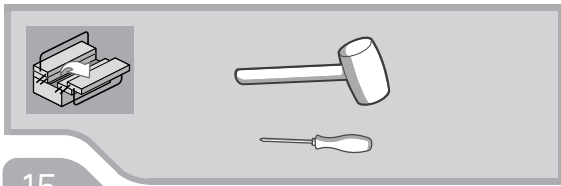
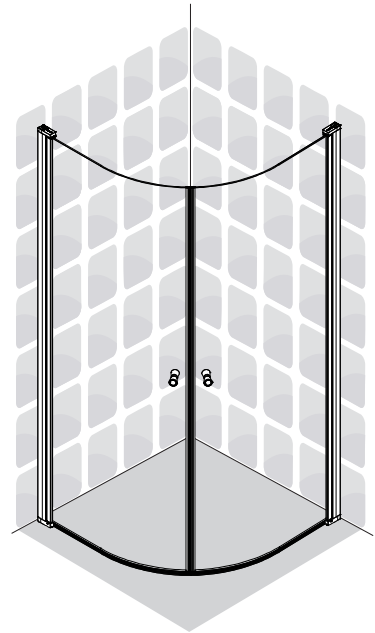
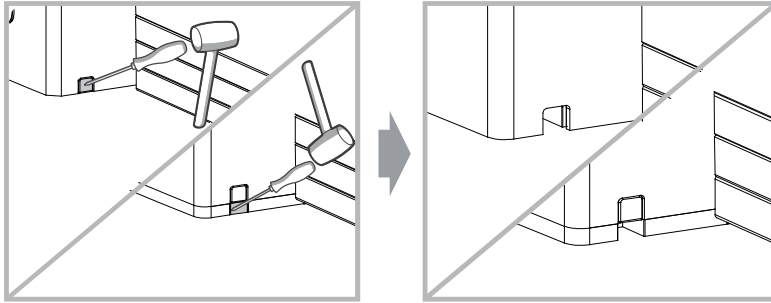

A	L
700	618
800	718
900	818
1000	918

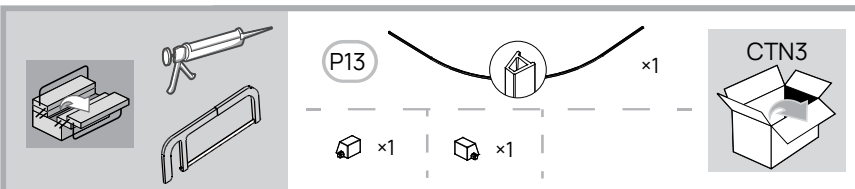
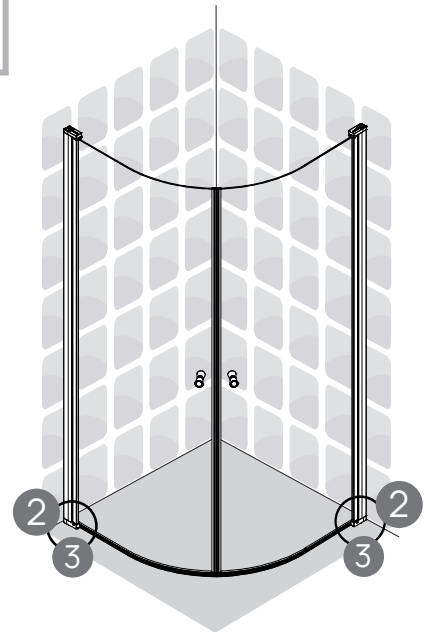
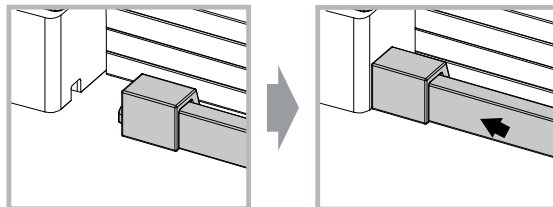
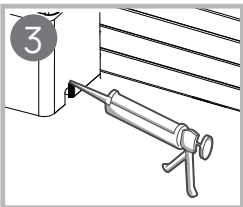
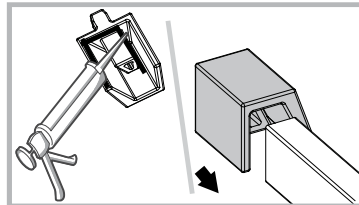
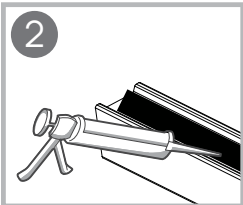

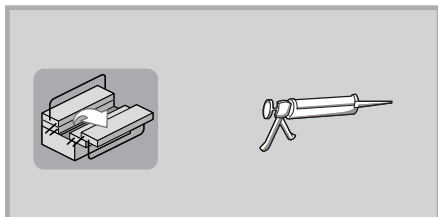
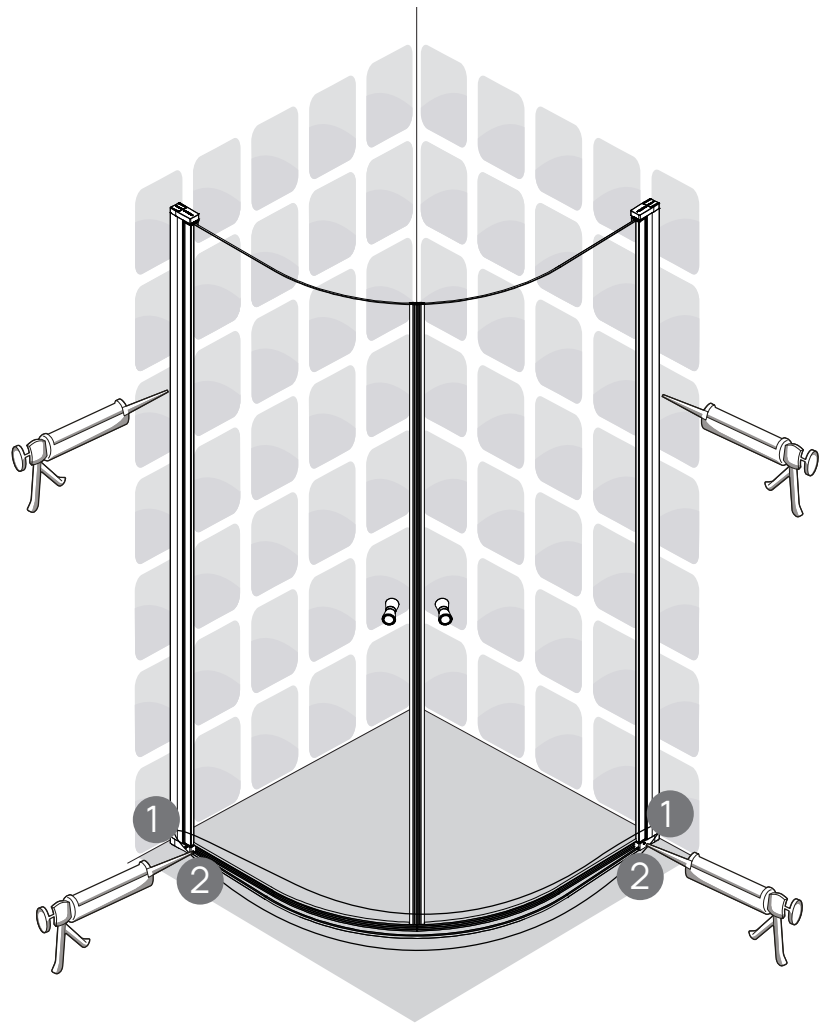
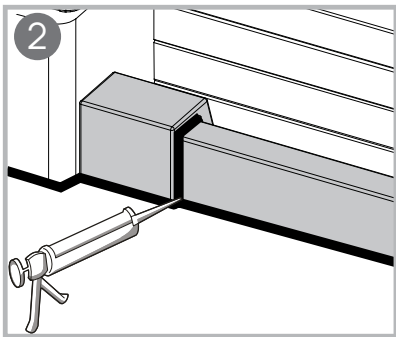
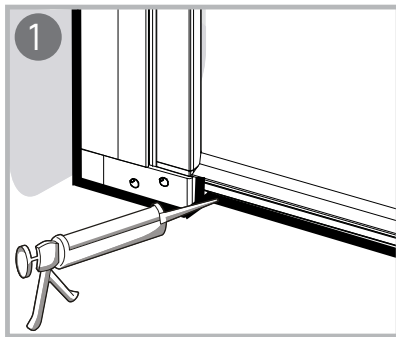
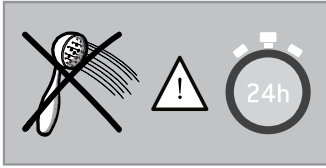

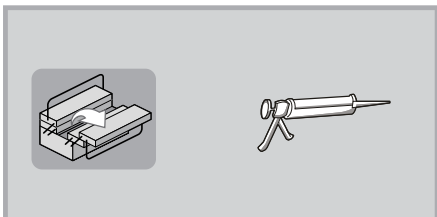
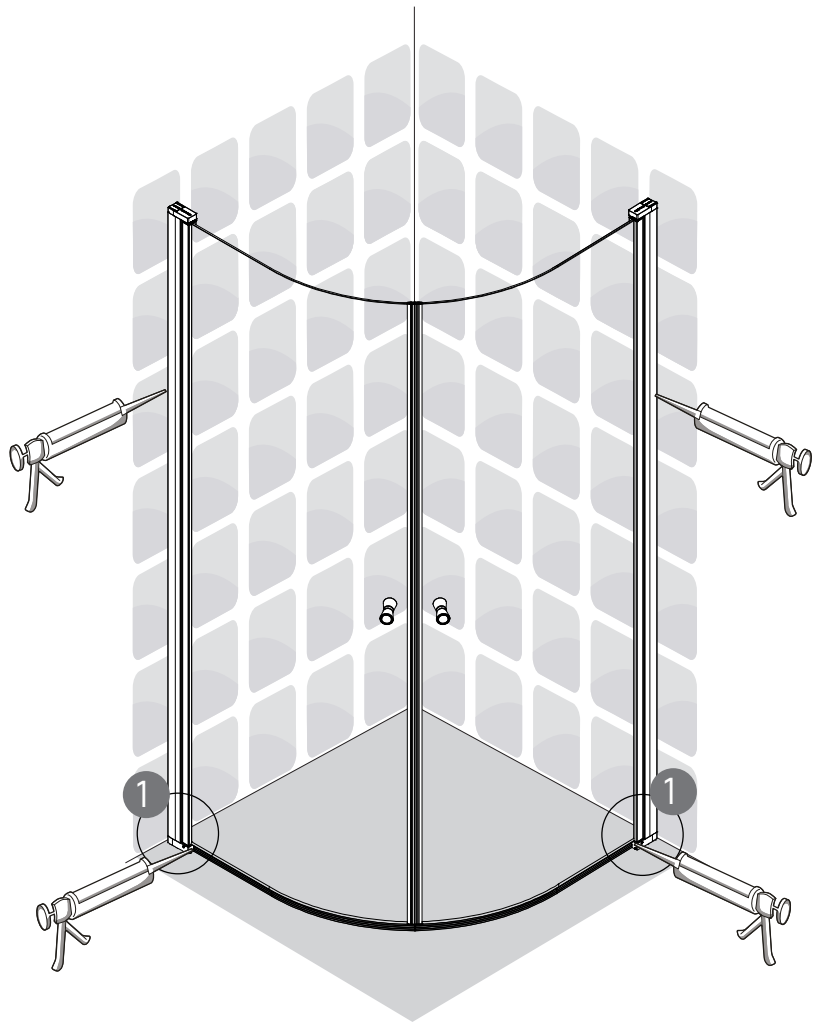
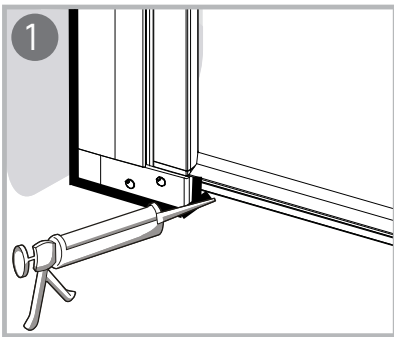
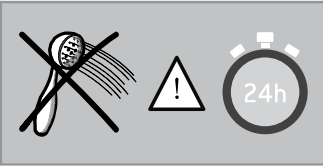

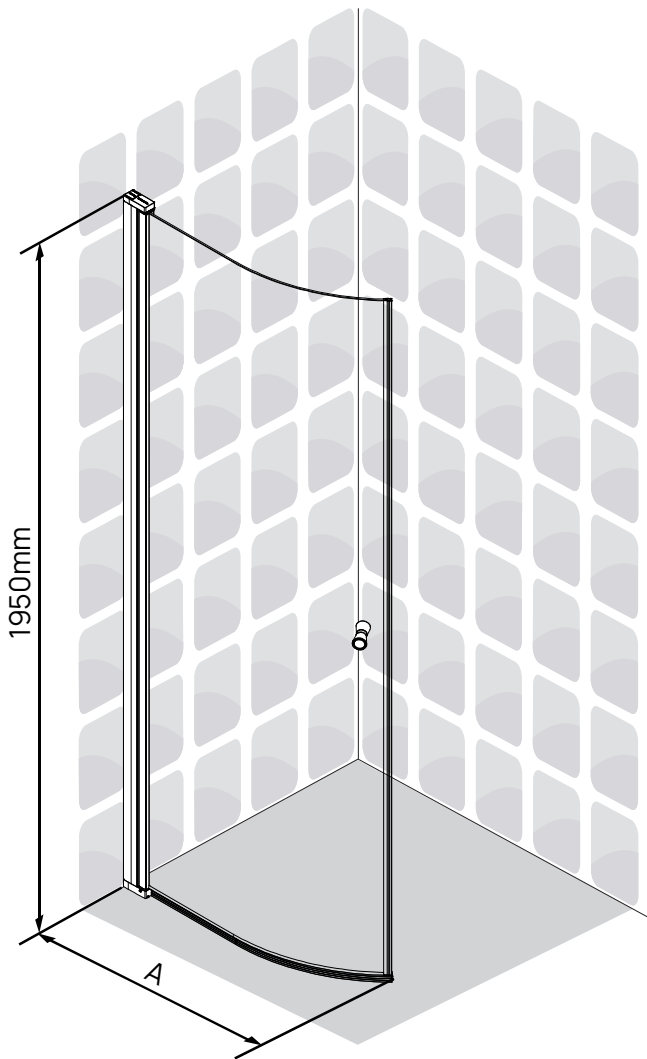
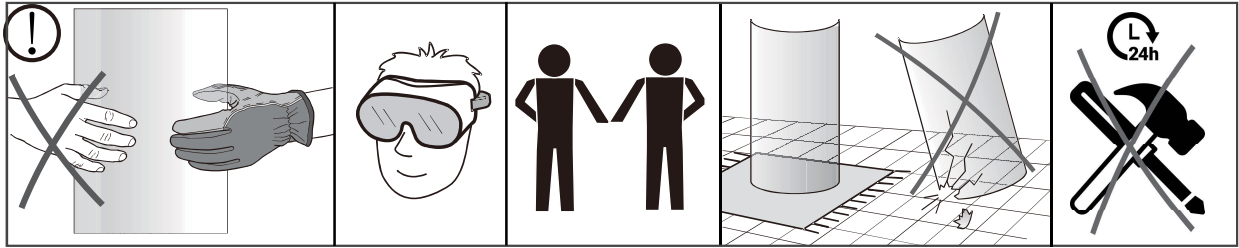

A	Min	Max
700	620	645
800	720	745
900	820	845
1000	920	945

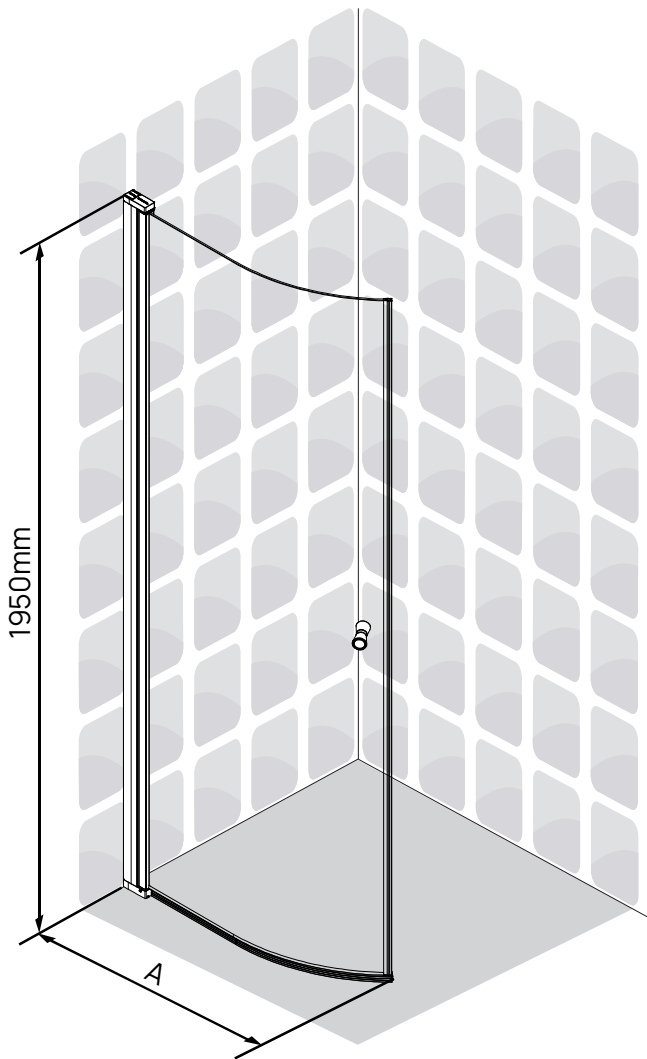
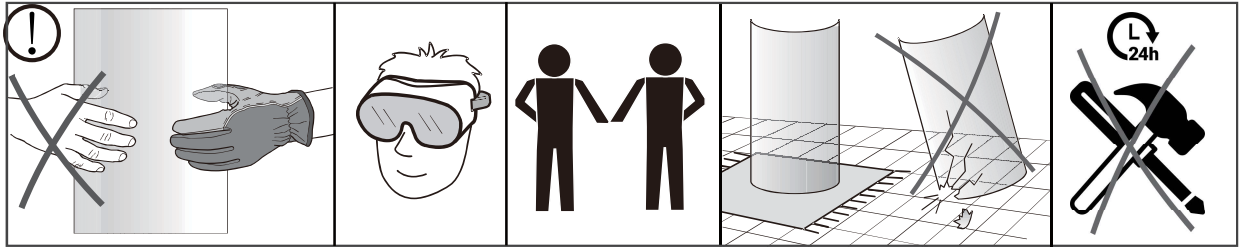

A	Min	Max
700	620	645
800	720	745
900	820	845
1000	920	945

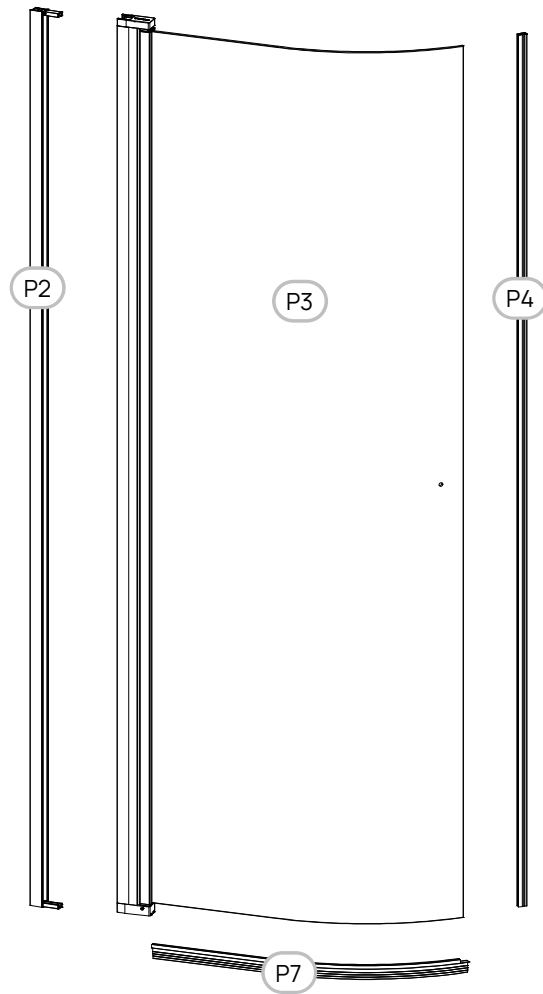
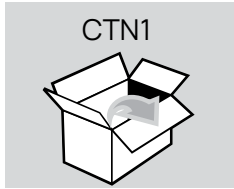
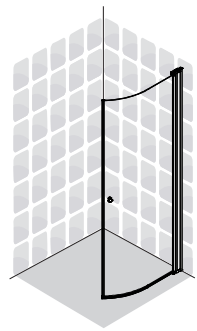
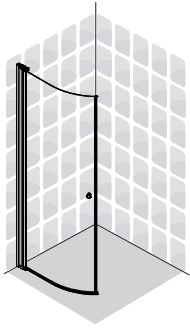

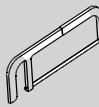
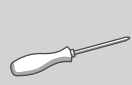
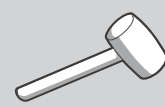
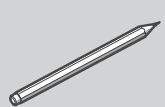
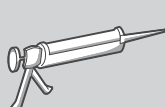
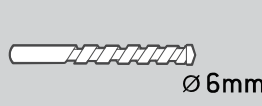
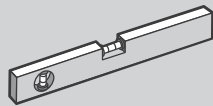
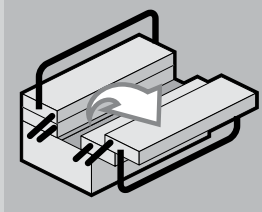
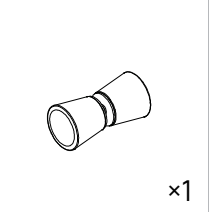
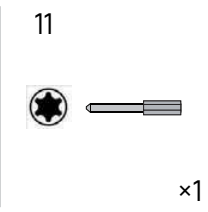
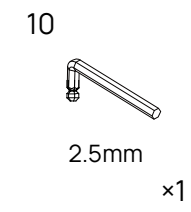
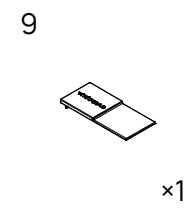
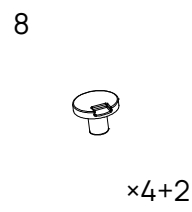
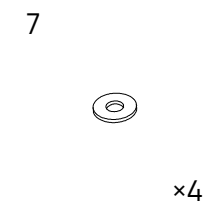
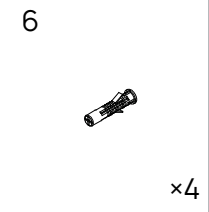
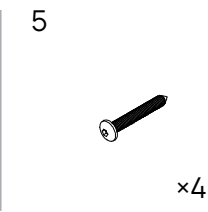
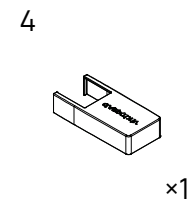
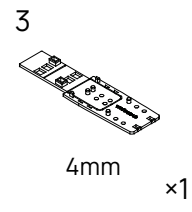
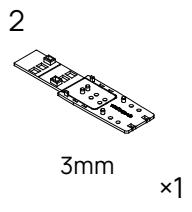
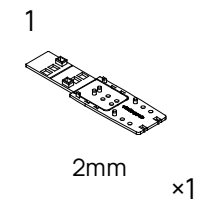
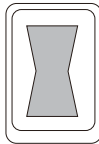
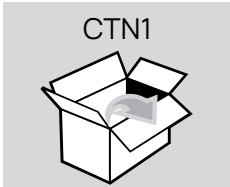

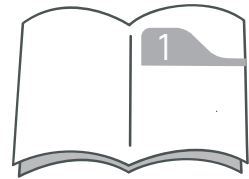
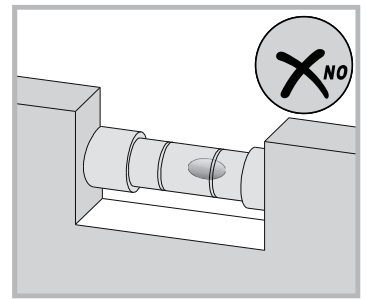
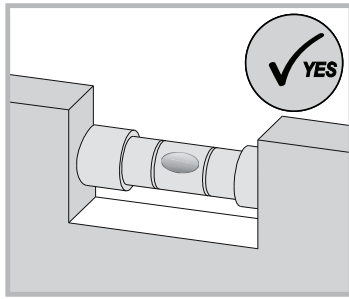
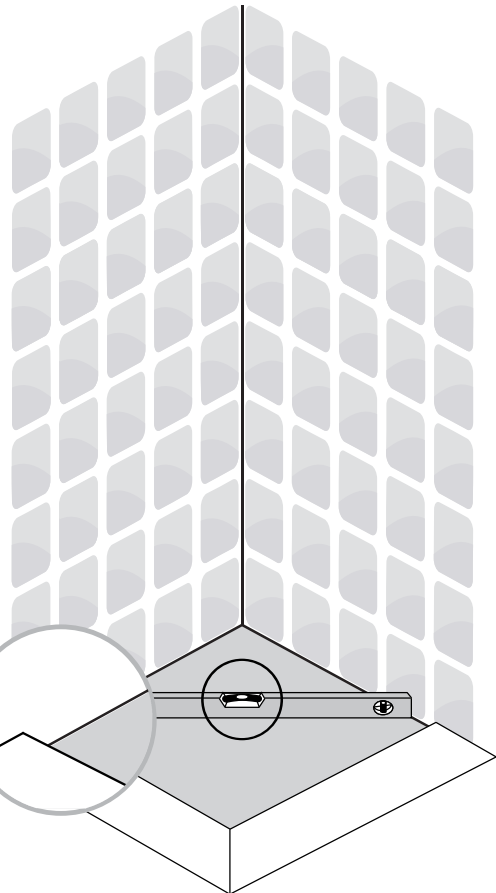
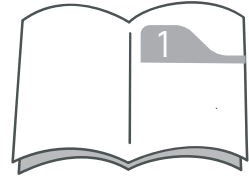
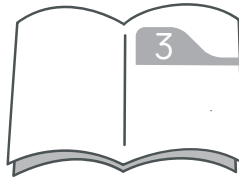
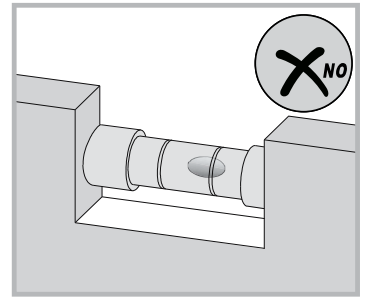
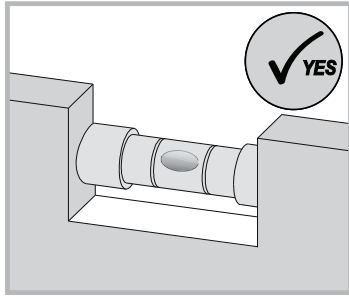
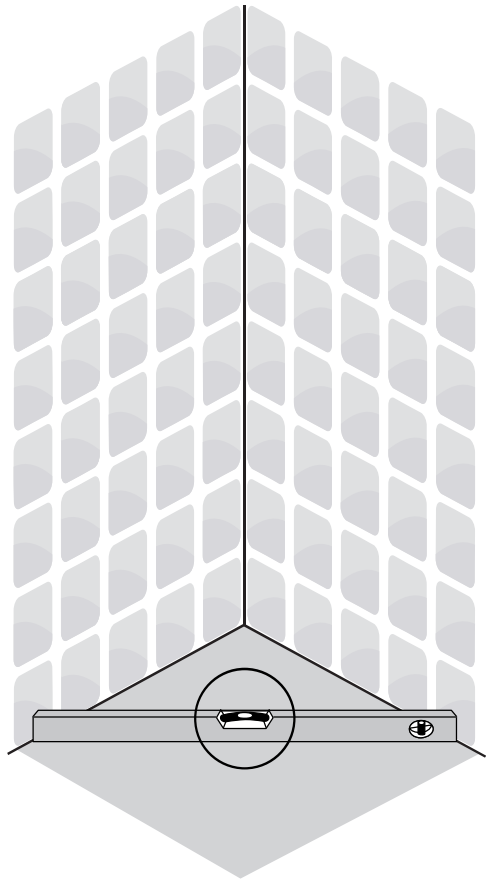

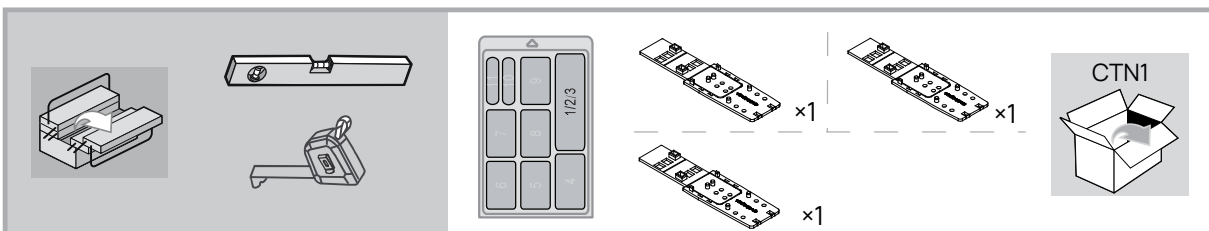
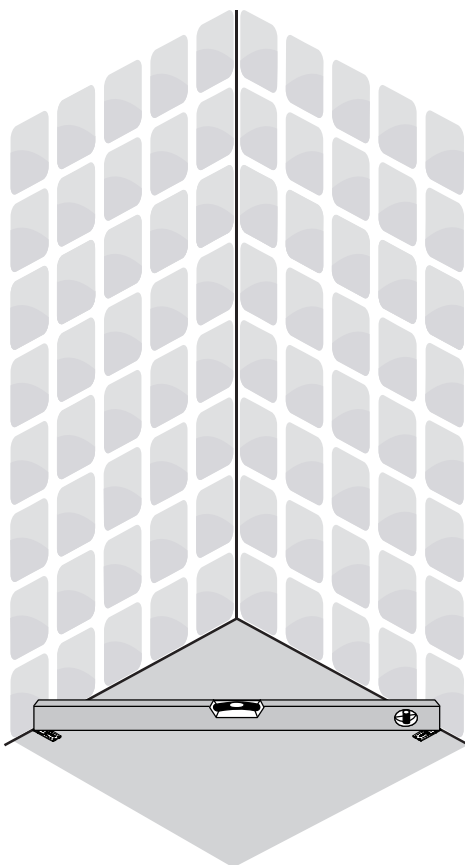
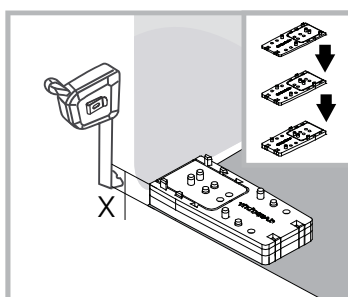
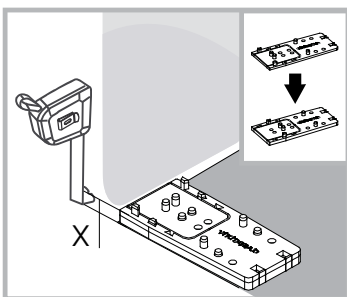
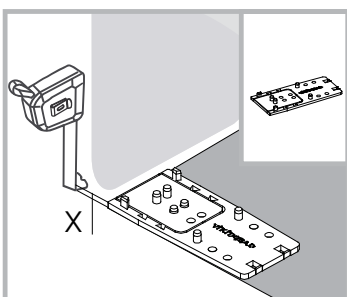
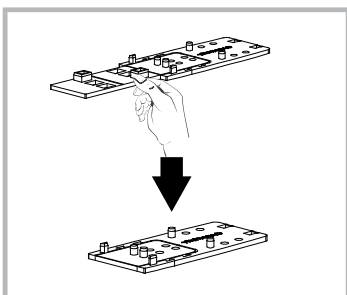
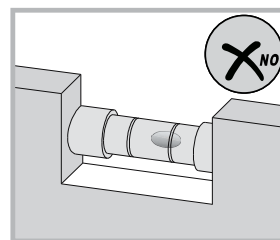
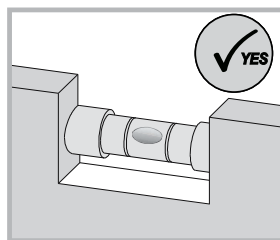
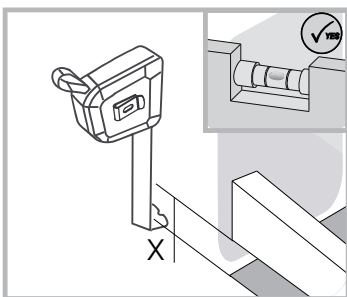

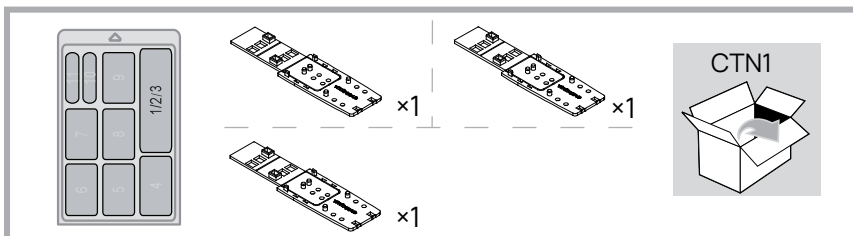
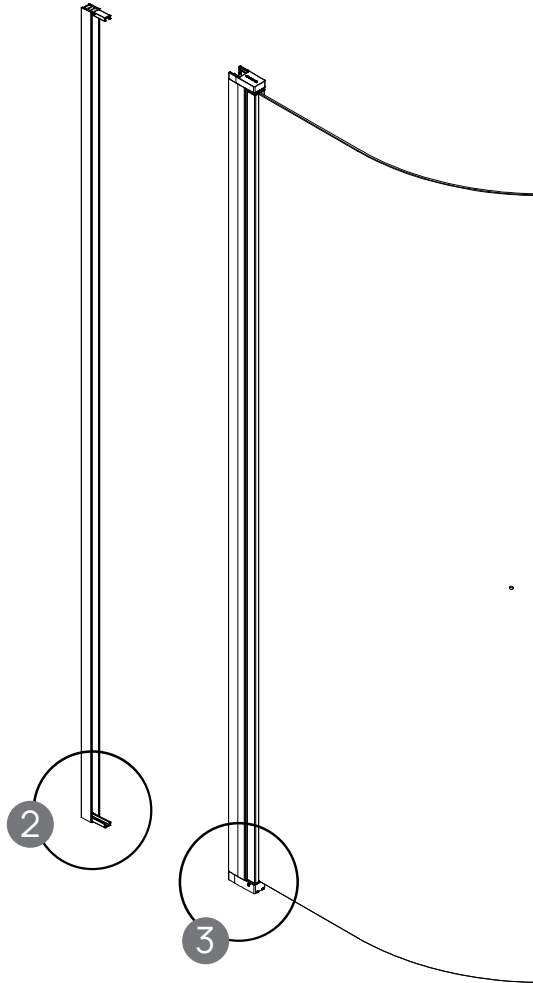
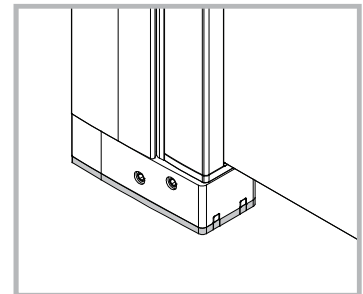
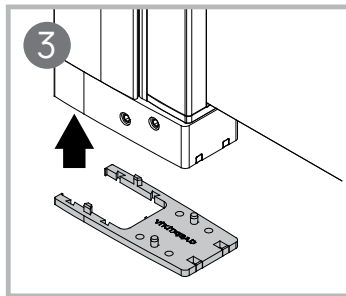
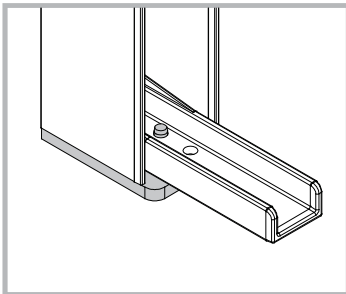
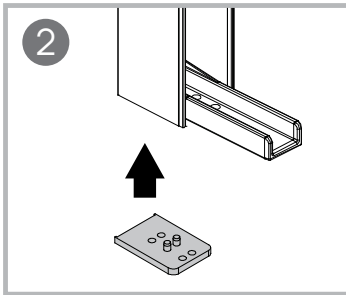
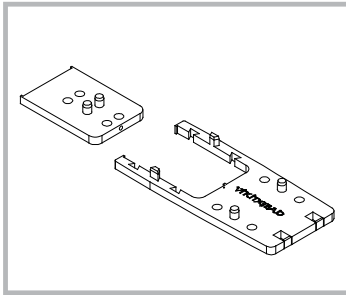
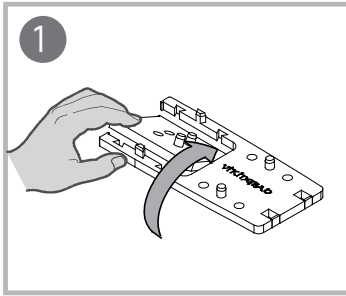

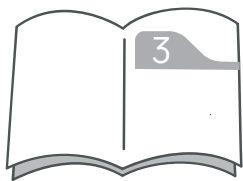
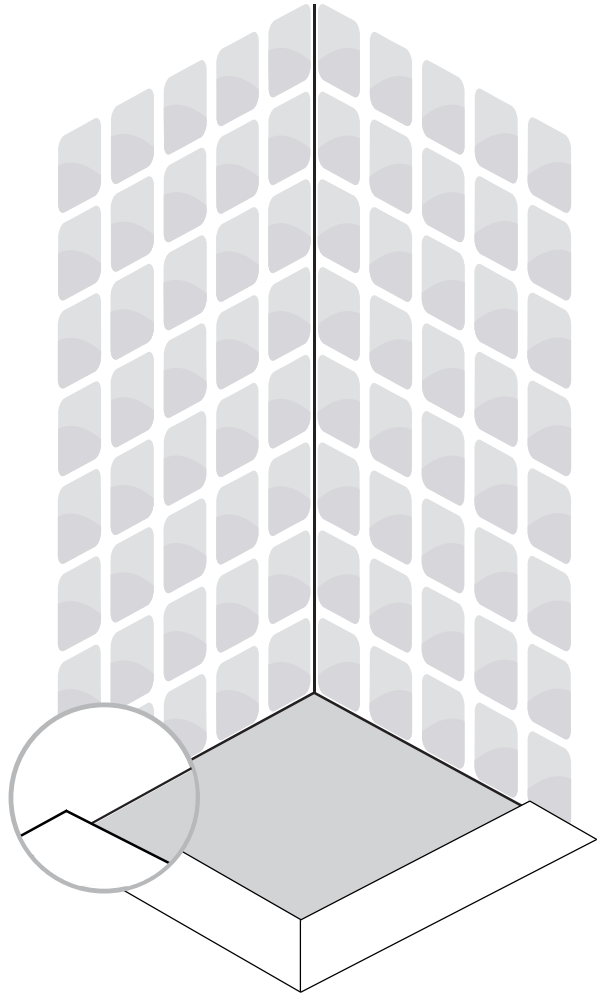
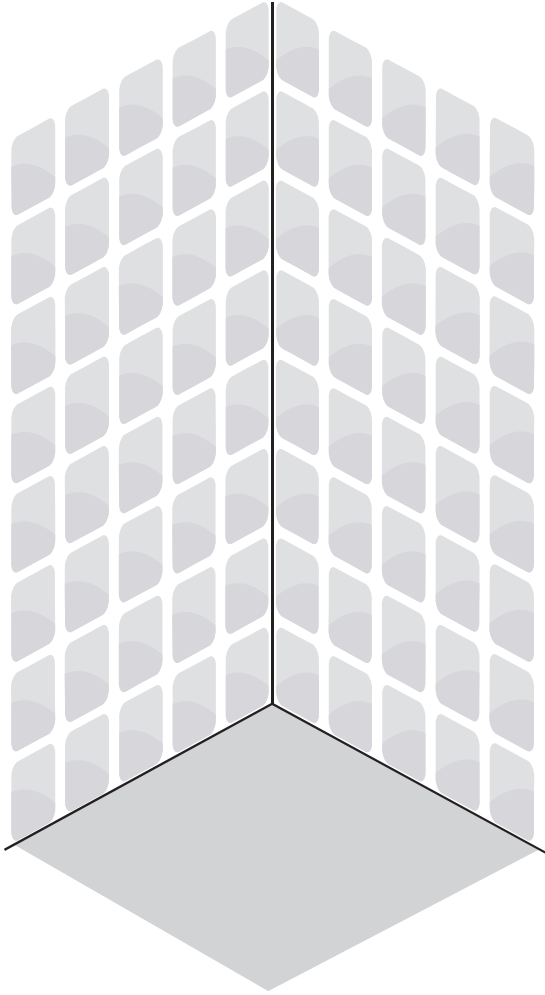

3

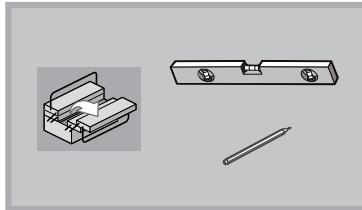
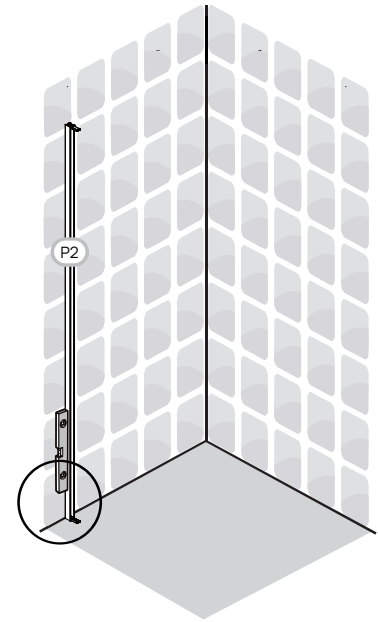
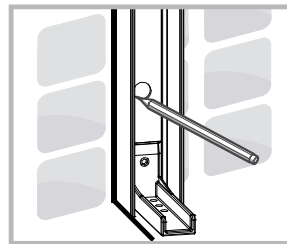
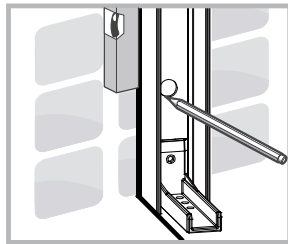
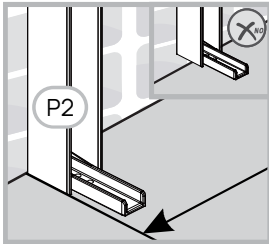
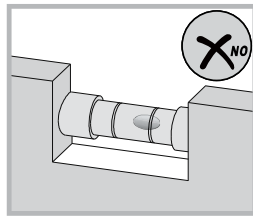
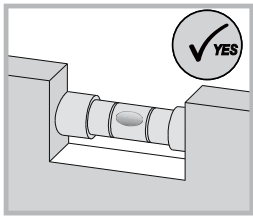

P2 → x1

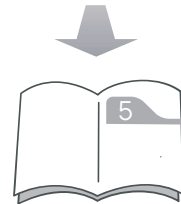
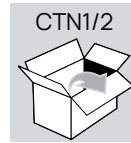

4

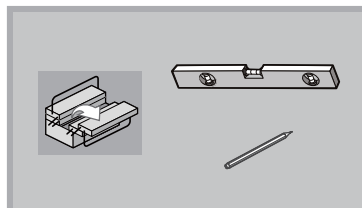
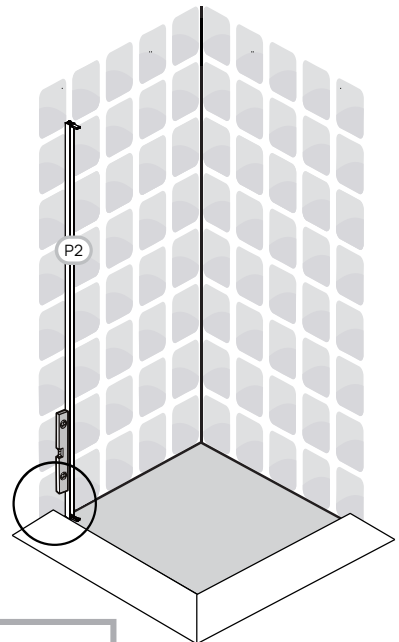
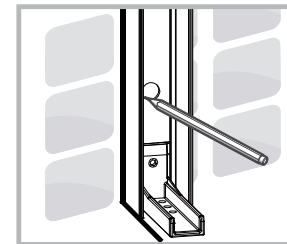
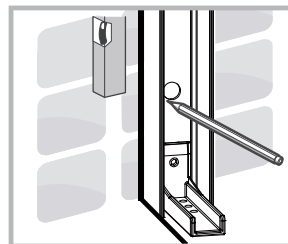
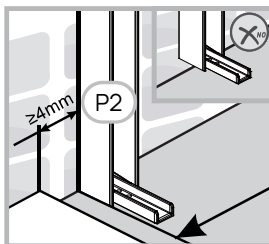
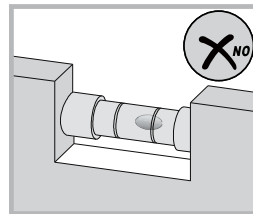
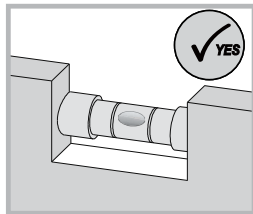

P2 → x1

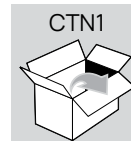

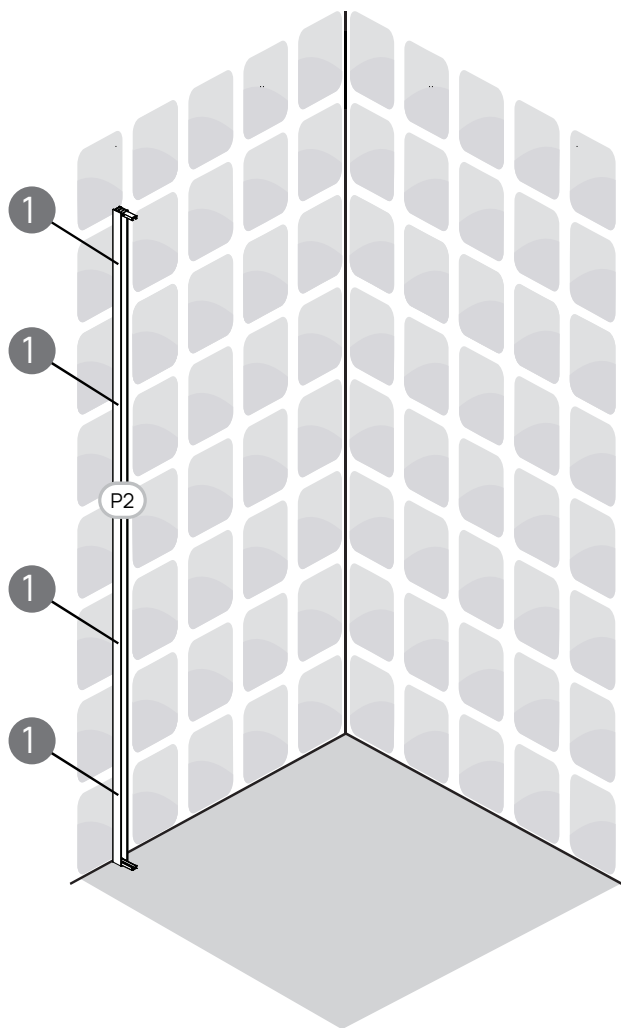
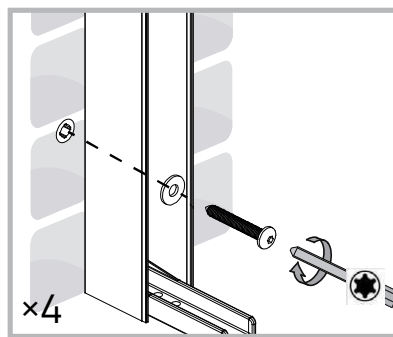
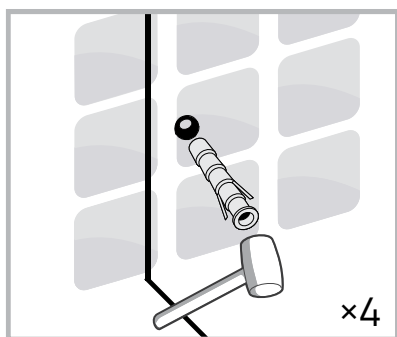
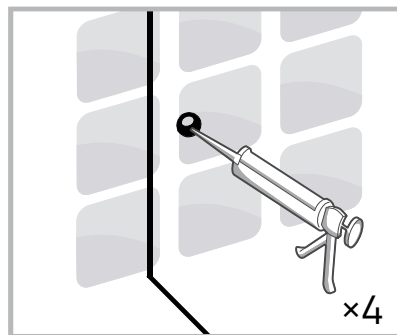
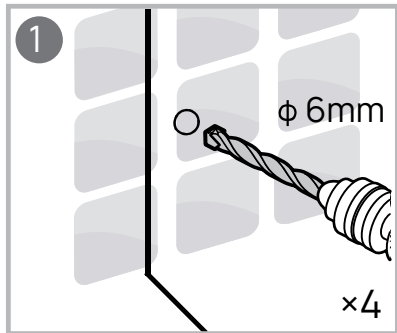

CTN1

x4

x4

x4

x4

x1

φ 6mm

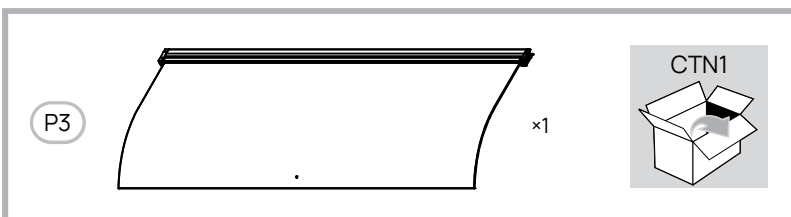
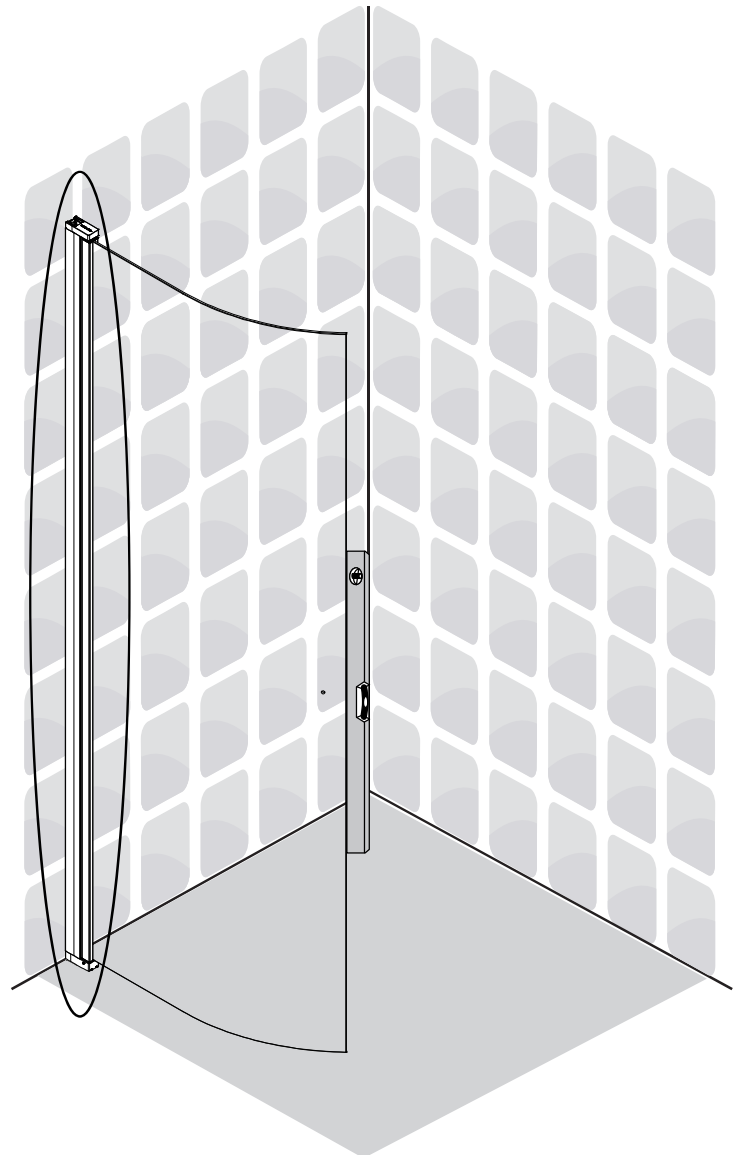
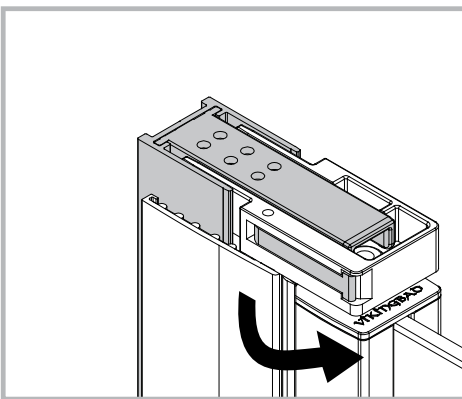
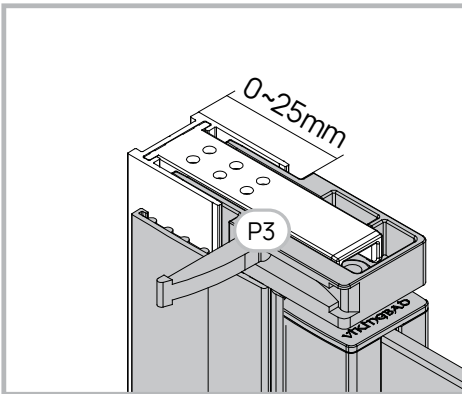
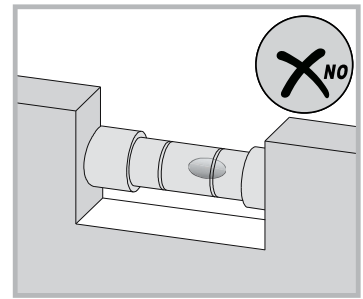
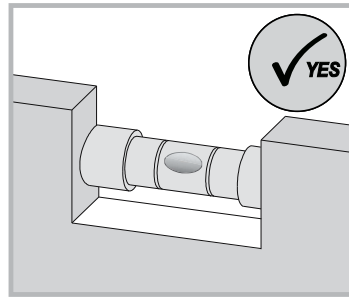
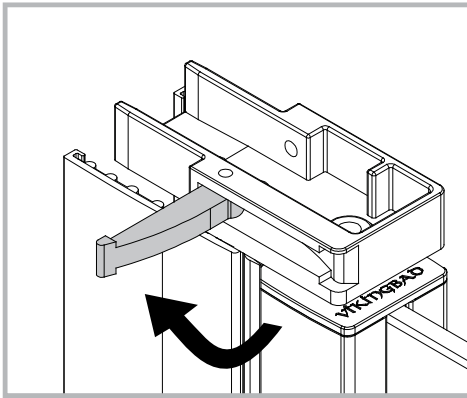

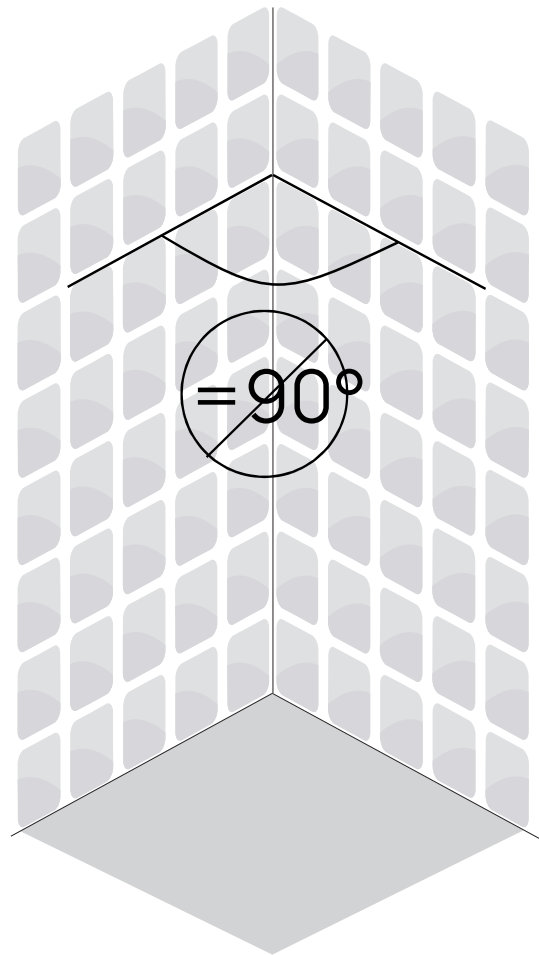
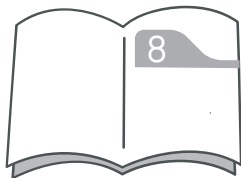
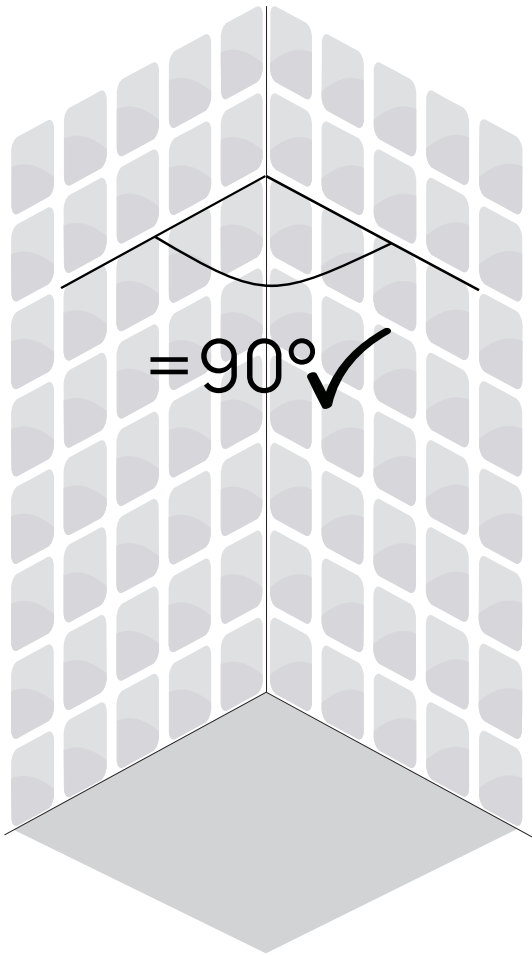

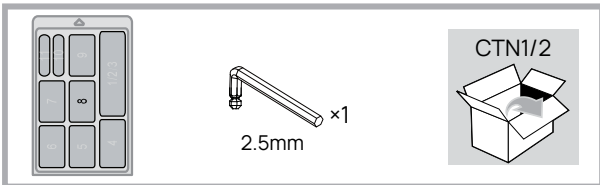
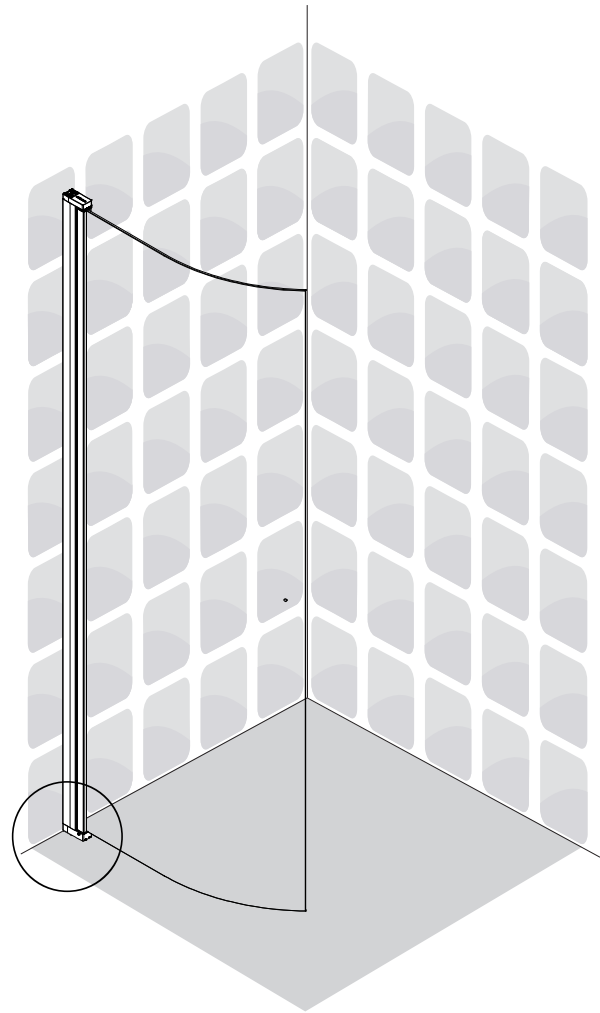
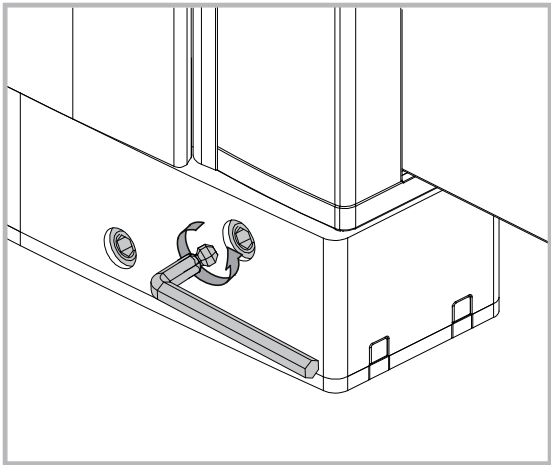
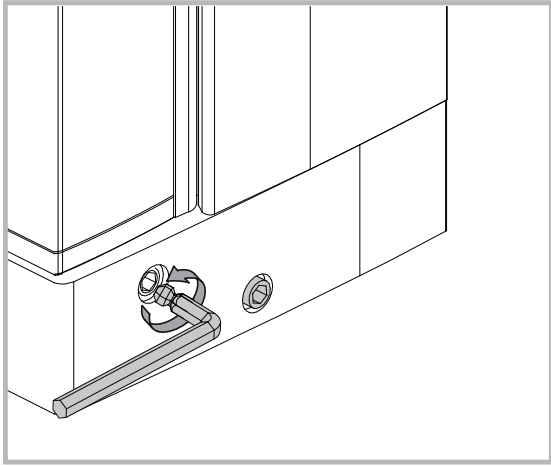

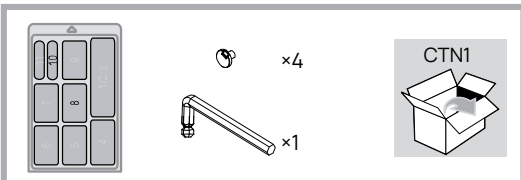
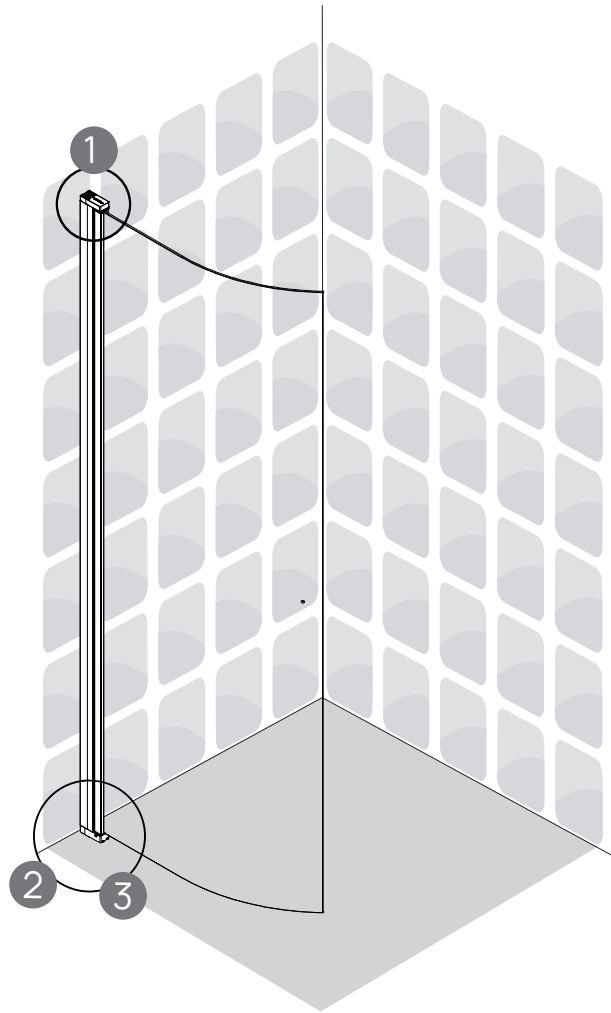
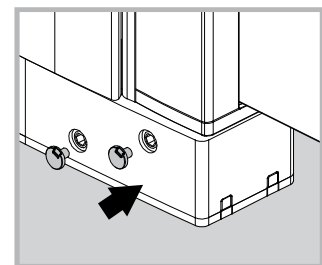
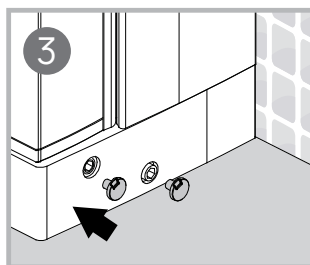
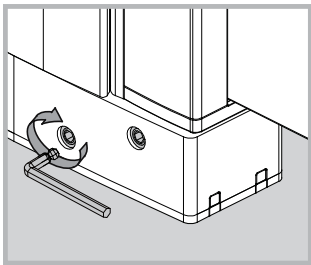
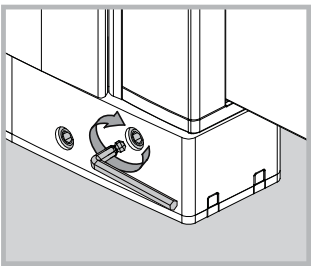
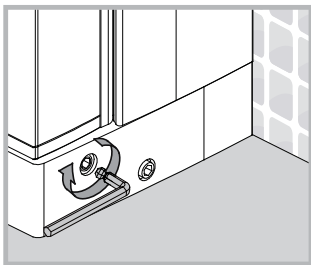
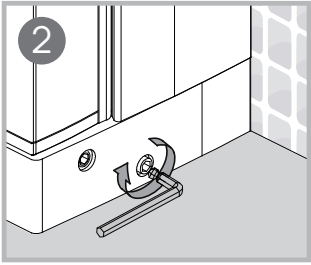
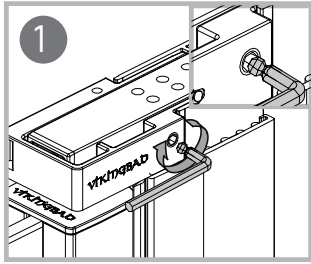

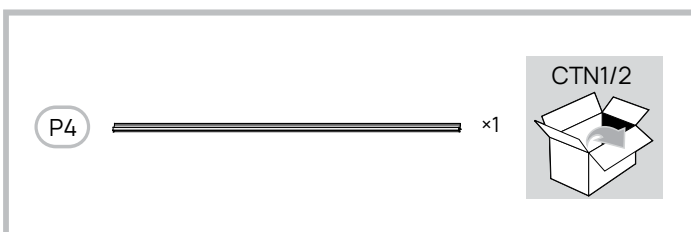
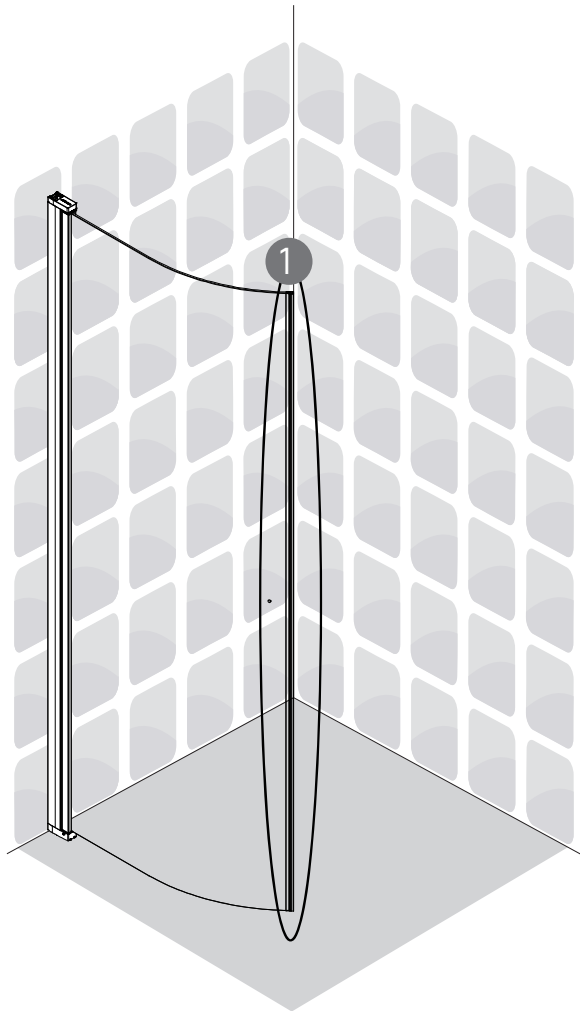
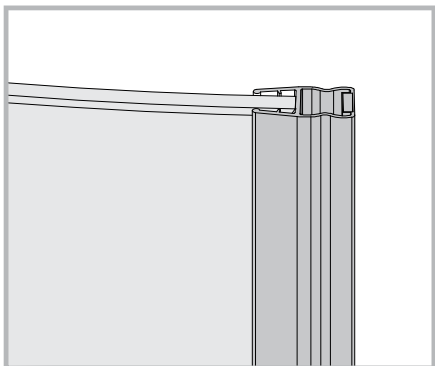
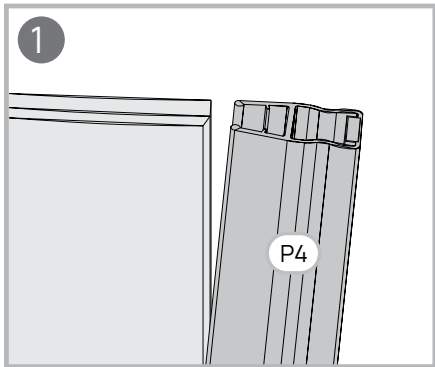

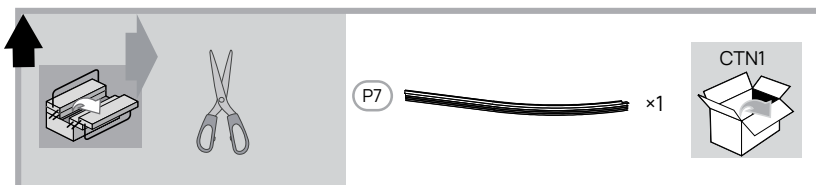
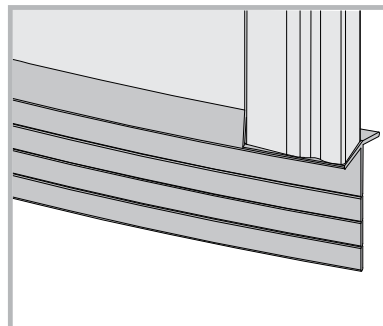
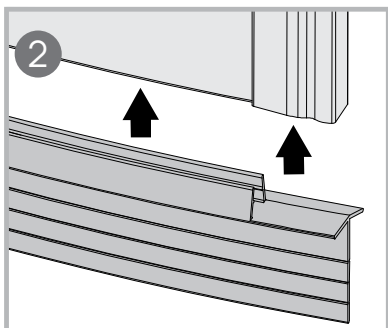
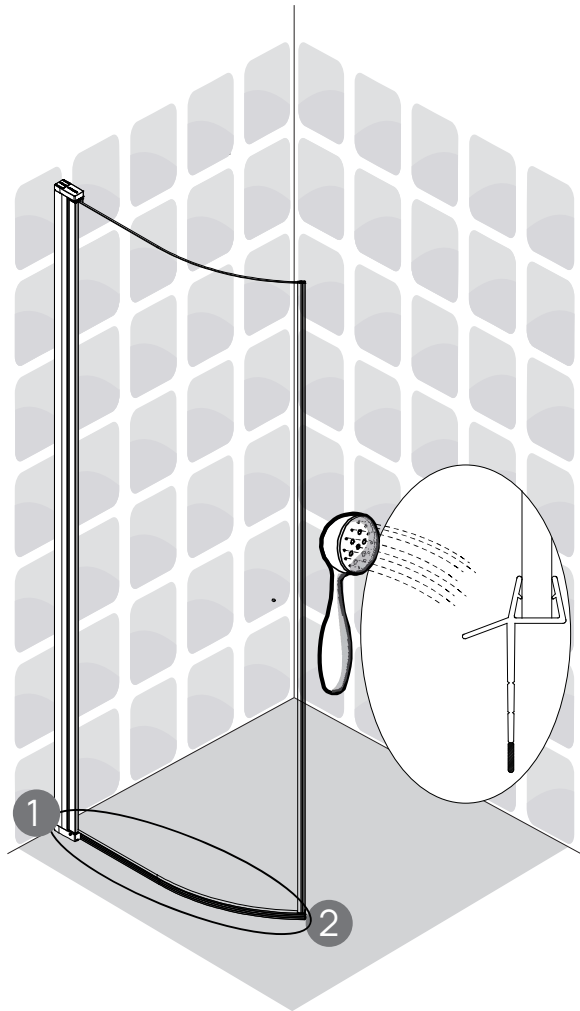
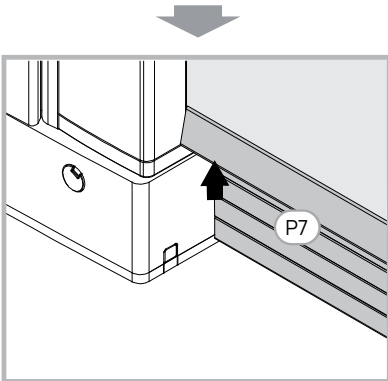
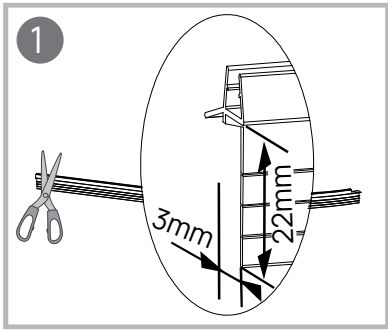

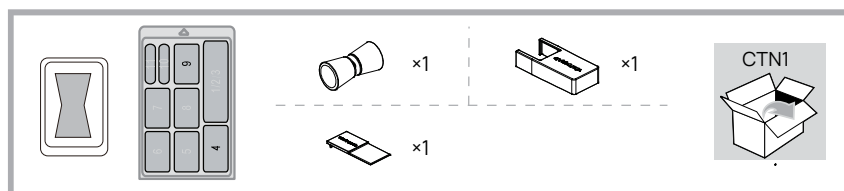
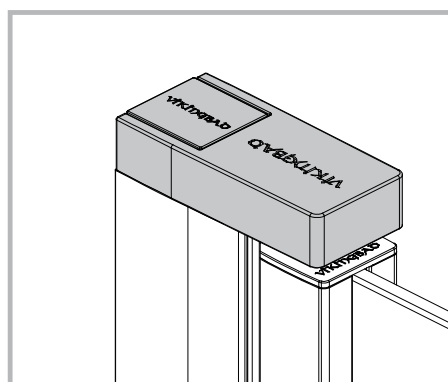
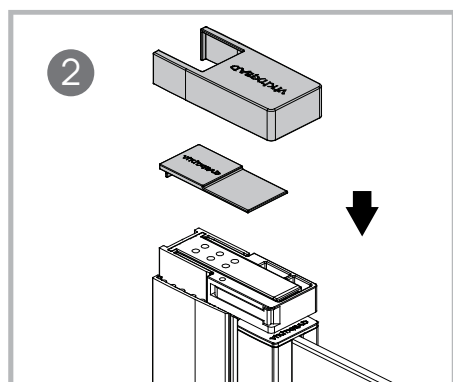
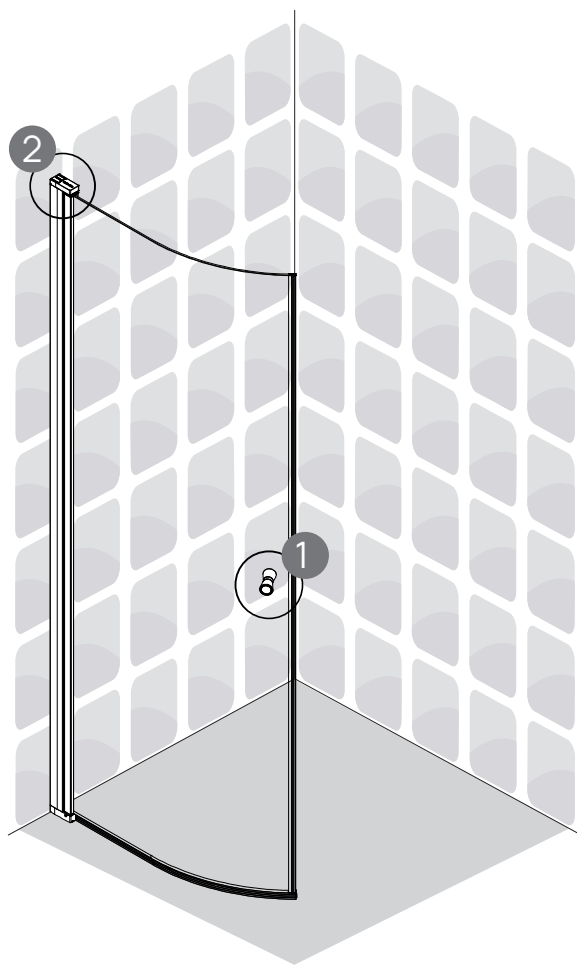
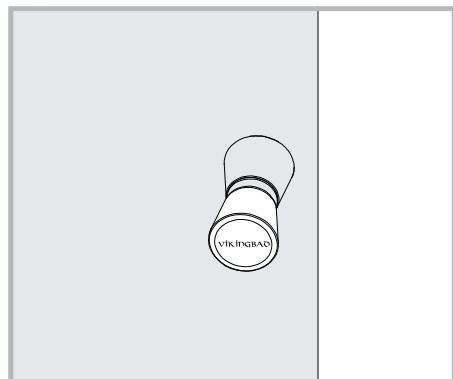
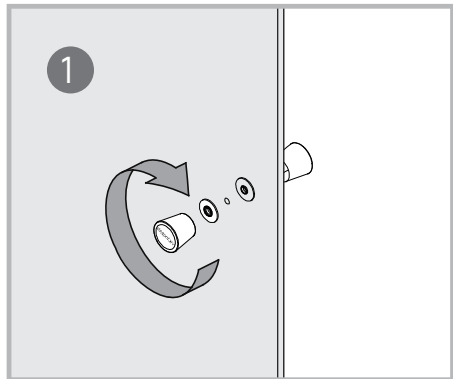

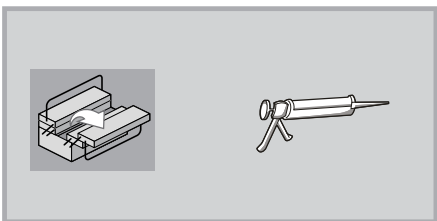
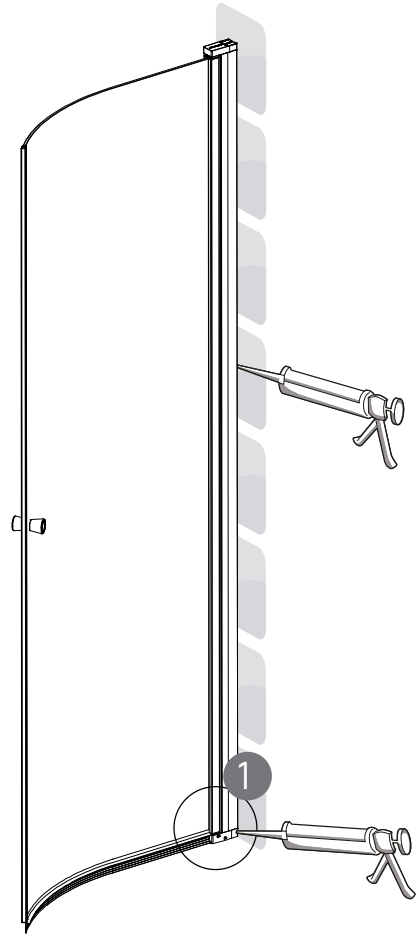
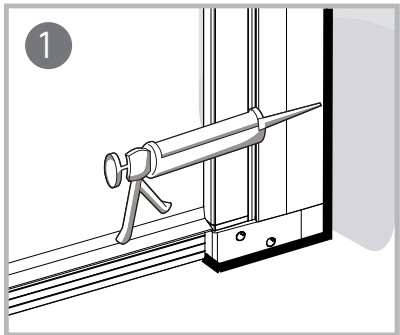
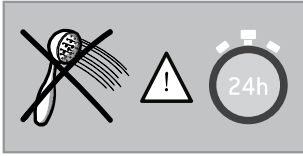

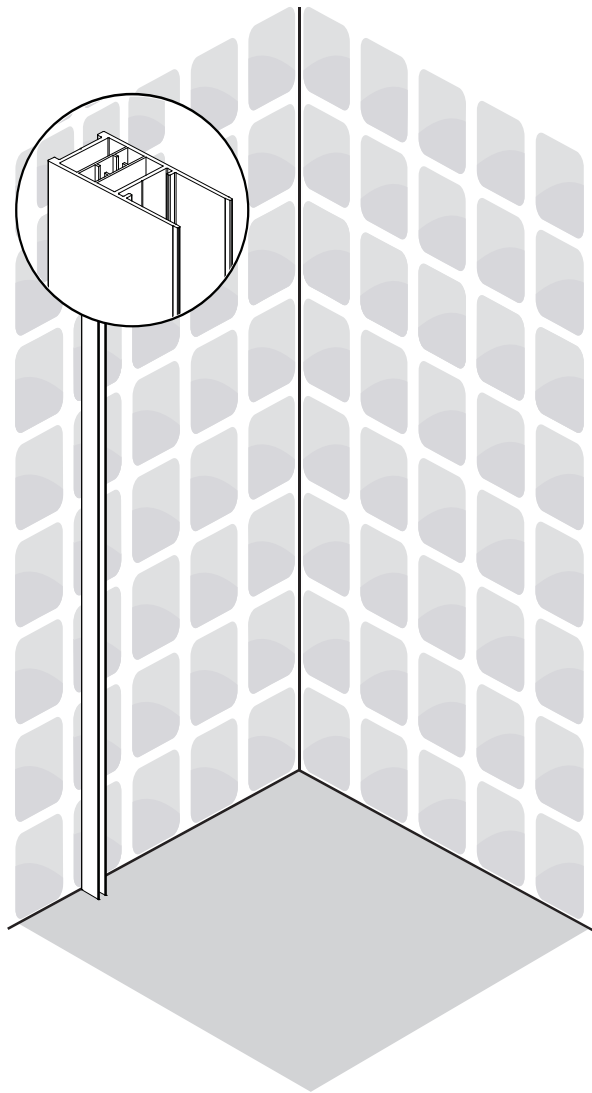
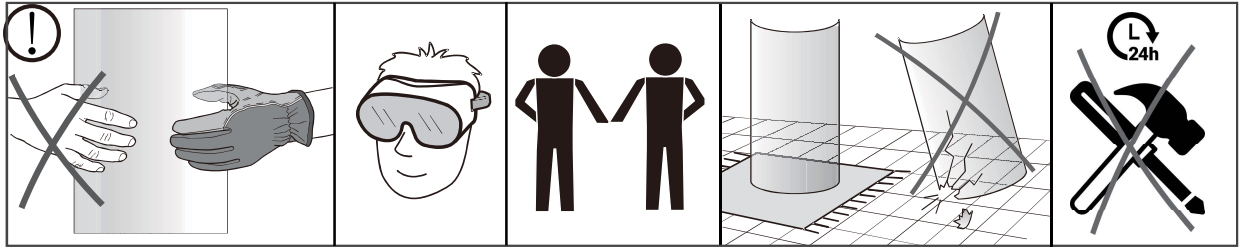

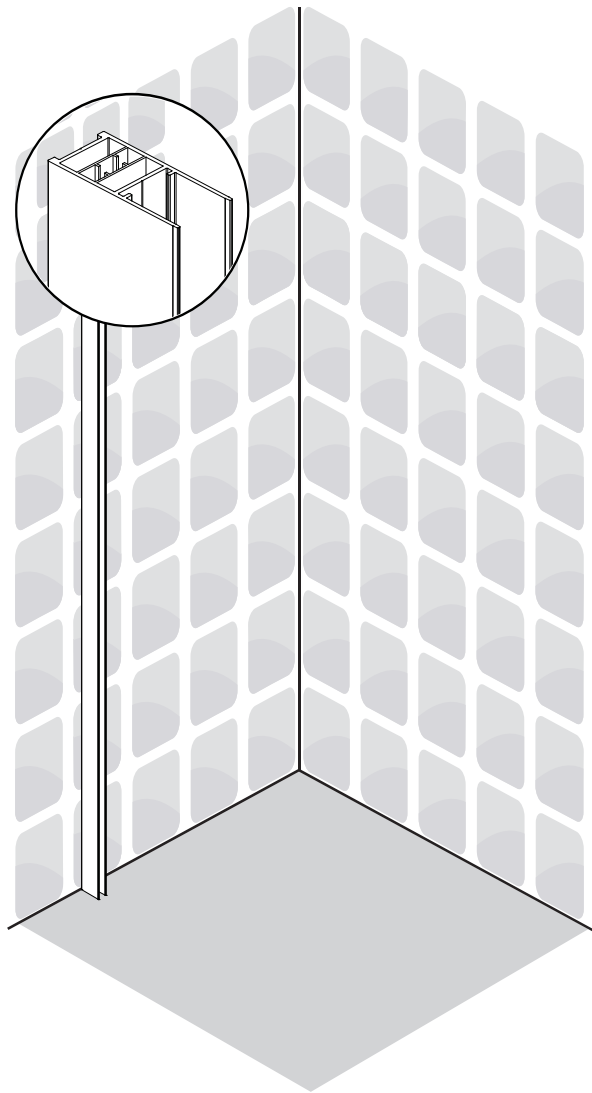
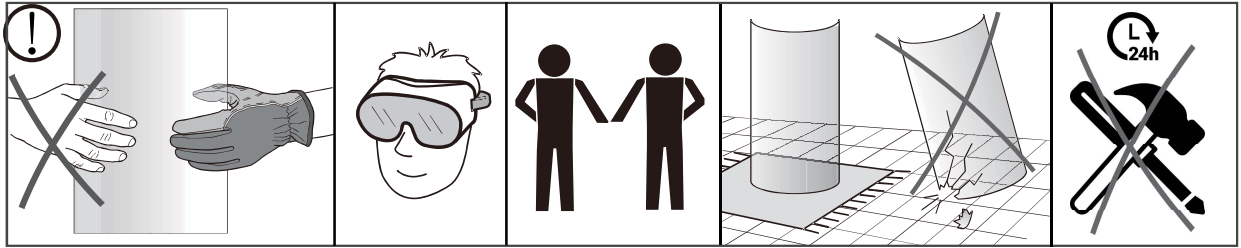

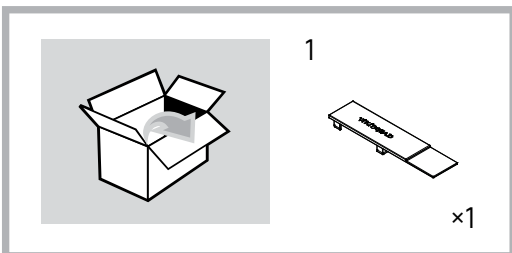
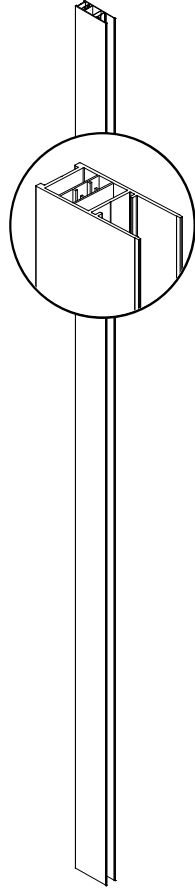
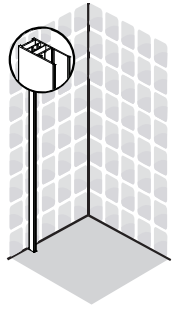

1

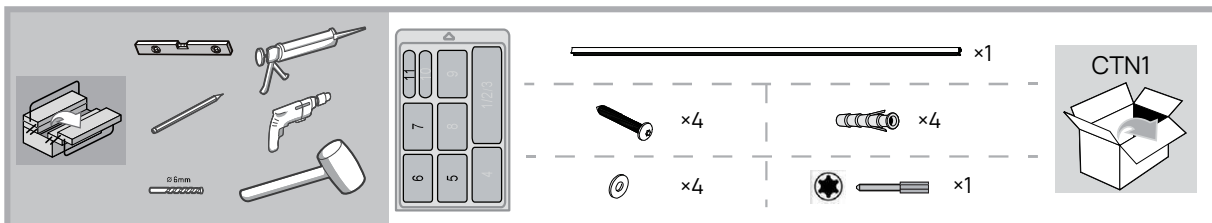
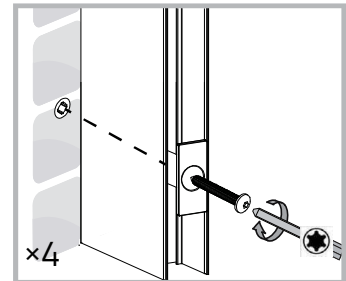
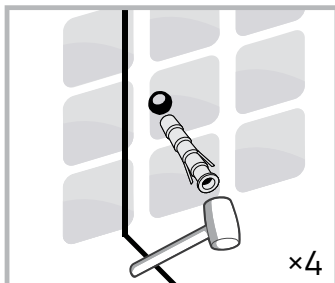
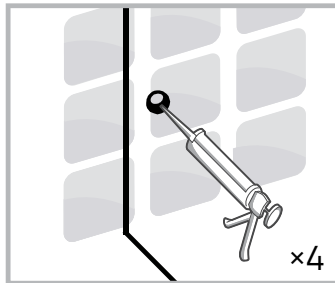
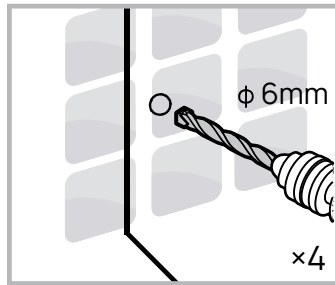
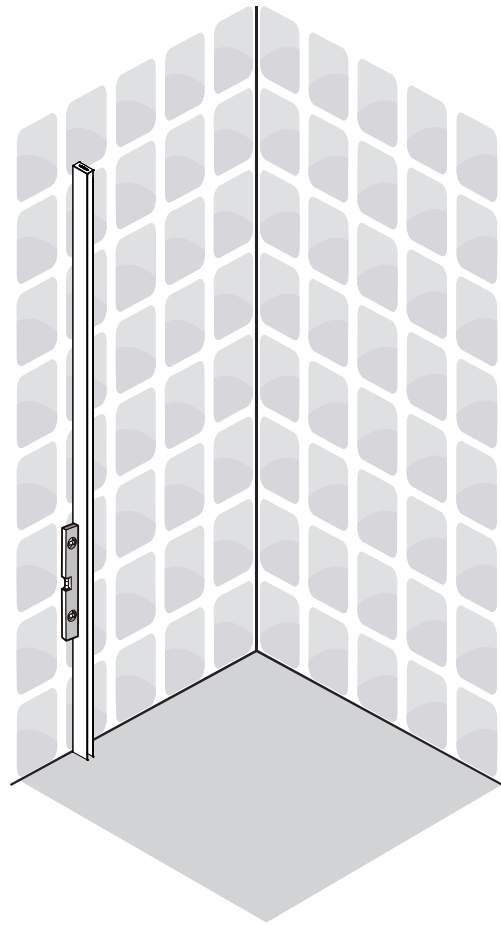
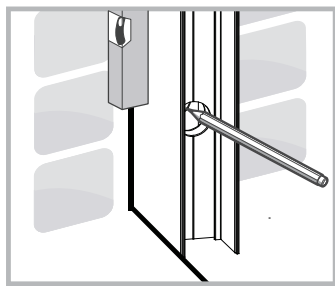
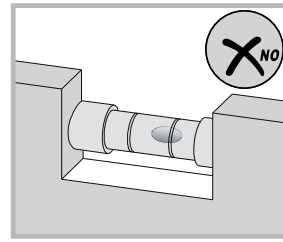
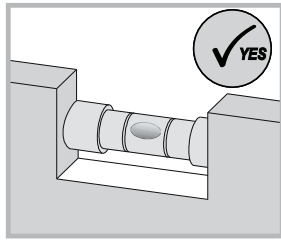
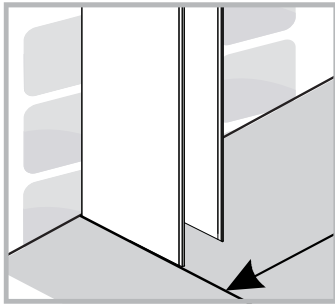

VEDLIKEHOLD

Under følger generelle vedlikeholdsinstrukser for å holde produktet vedlike:

- ✓ Vi anbefaler rengjøring med vaskemidler beregnet for baderom. Bruk en myk klut og unngå bruk av f.eks skuresvamp da dette kan lage riper på produktet. Vann og såperester tørkes av umiddelbart. Unngå: Rengjøringsmiddel med skure-effekt eller innholdende løsmidler! Eksempel: Syrer, klorin, kaustisk soda og amoniakk (salmiak) må ikke brukes!
- ✓ Det er anbefalt å bruke en dusjnal for å fjerne vann fra overflater etter bruk. Dette vil forenkle det daglige vedlikeholdet.

GARANTIVILKÅR

Vikingbad AS følger norsk kjøpslov med 5 års reklamasjonsrett på fabrikkfeil.

VED REKLAMASJON / SERVICE

Arbeid dekket av Vikingbad AS:

- ✓ Transport tur/retur til kunde.
- ✓ Selve servicearbeidet med reservedeler/ reklamasjonsproduktet.
- ✓ Gjenmontering og silikonerer.

HVA ER IKKE DEKKET AV KJØPSLOV ELLER GARANTI:

- ✓ Alle følgefeil forårsaket av frostkader som kunde kunne forhindre dekket ikke av reklamasjon
- ✓ Feil som følge av fysisk skade eller ytre påvirkning
- ✓ Feil/skader som følge av feil montering/tilkobling/reparasjoner/endringer av uautorisert personell eller bruk av ikke-originale reservedeler i forbindelse med service/reparasjon.
- ✓ Kostnader som Vikingbad AS ikke er direkte skyld i, som f.eks tap av fortjeneste eller annen skade på person/eiendom.
- ✓ Skade/feil på produktet som skyldes feil bruk eller som er i strid med prosedyrer beskrevet i denne brukermanualen.
- ✓ Skraper/riper i overflaten ansees som vanlig slitasje.
- ✓ Skader oppstått grunnet bruk av ikke-anbefalte vaskemidler. Eks syrer og vaskemidler med slipende effekt
- ✓ Vikingbad AS fraskriver seg ansvaret for kostnader i forbindelse med reklamasjoner, service eller annet utover selve produktet.

VIKTIG MED TANKE PÅ REKLAMASJON:

Produktet må være tilgjengelig for serviceperson ved reklamasjon. Det er kjøpers ansvar å sørge for at produktet er tilgjengelig. Dersom fliser, toalett, baderoms møbler eller lignende må demonteres eller eventuelt produkt må løftes opp/ut av innbygning for at serviceperson skal komme til selve produktet påligger dette ansvaret på kjøper. Tid serviceperson bruker for å gjøre produktet tilgjengelig for service/reklamasjon inngår ikke i garanti og faktureres etter timepris.

GARANTI GJELDER KUN SAMMEN MED GYLDIG KVITTERING OG SERIENUMMER I DET LAND PRODUKTET ER KJØPT.

Denne brukermanualen og innholdet kan endres uten varslings. Selv om Vikingbad AS har utarbeidet brukermanualen så nøyaktig som mulig, vil ikke Vikingbad AS være økonomisk ansvarlig for tap og skader som følge av feilaktig installasjon, service eller bruk. Vikingbad AS tar også forbehold om produktendringer og trykkfeil i brukermanualen.

Samsvarserklæring Vikingbad

Leverandør: Vikingbad AS
Østerskogen 35
4879 Grimstad
NORWAY

Produktbeskrivelse: Vikingbad Liam Dusjdør buet

Modeller: VB-003725-01, VB-003725-02, VB-003725-03, VB-003726-01, VB-003726-02, VB-003726-03, VB-003727-01, VB-003727-02, VB-003727-03, VB-003728-01, VB-003728-02, VB-003728-03

Vikingbad AS bekrefter at ovennevnte produkter er testet og funnet i samsvar med følgende teststandard:

EN 12600

EN 14428:2015+A1:2018

A handwritten signature in black ink, reading 'Kristian Schlanbusch'.

Kristian Schlanbusch
Produktansvarlig Vikingbad as

2019.07.06