

VIKINGBAD

INSTALLASJONSMANUAL VIKINGBAD LOKKAVLØFTER PLUSS



Innhold i esken:

Festebraketter # 1



Vinkelrør # 2

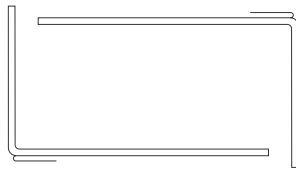

Topprør # 3

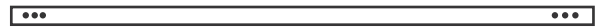

Svingarmer # 4



Justerbare braketter # 5

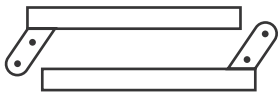

Løftesylder # 6

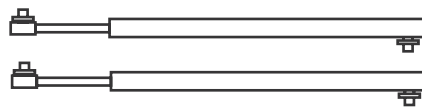

Sikkerhetshåndtak # 7



Braketter for undermontering # 8

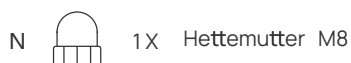
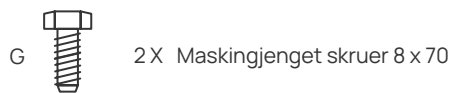
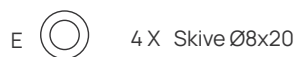
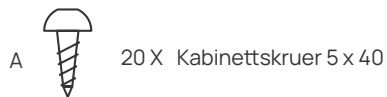
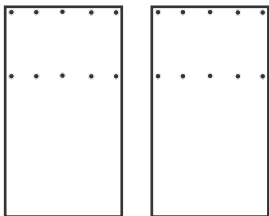

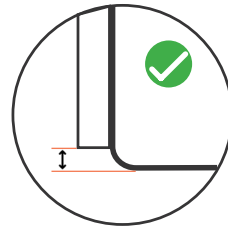
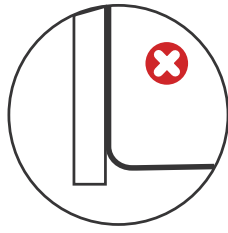

Min 6cm

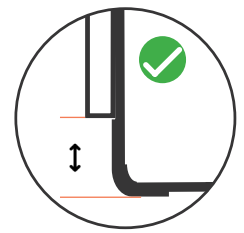

Max 15cm

Alternativ 1 - Sidemontert

1

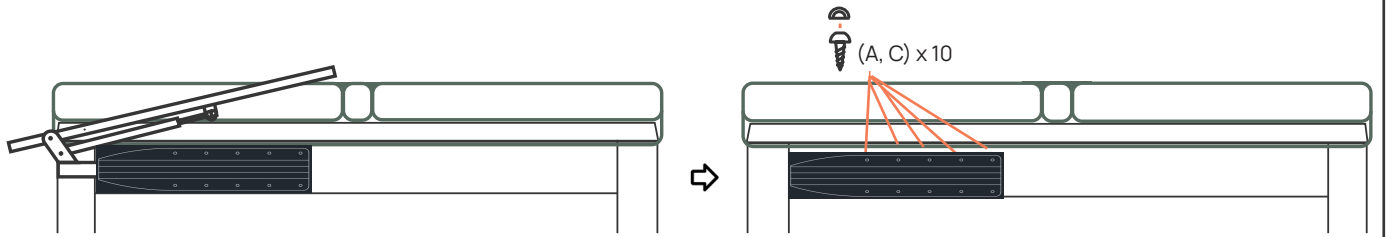

Alternativ 2 - Terrassemontert

1

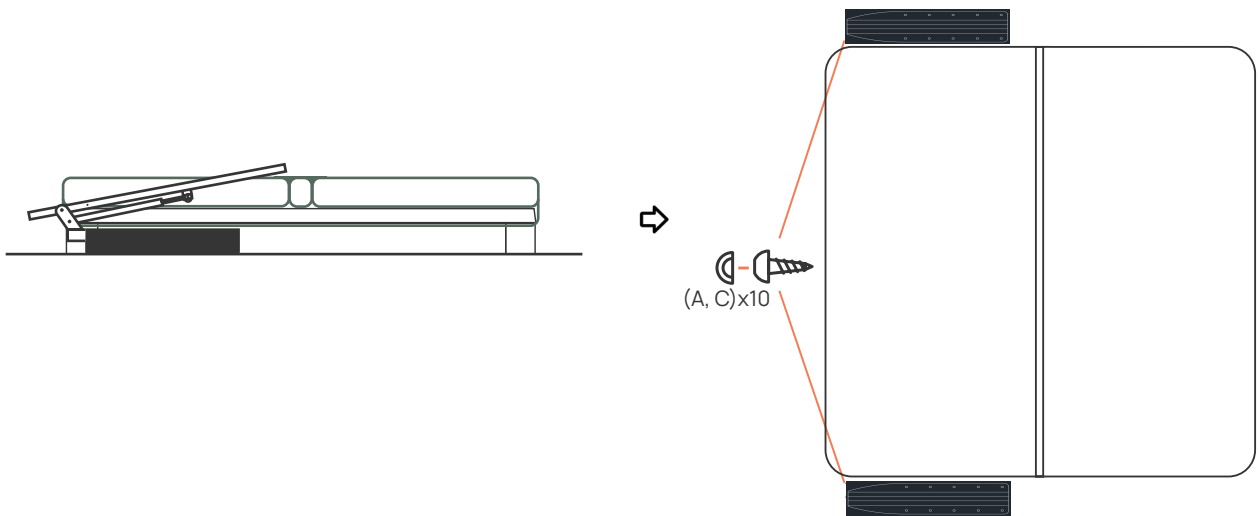

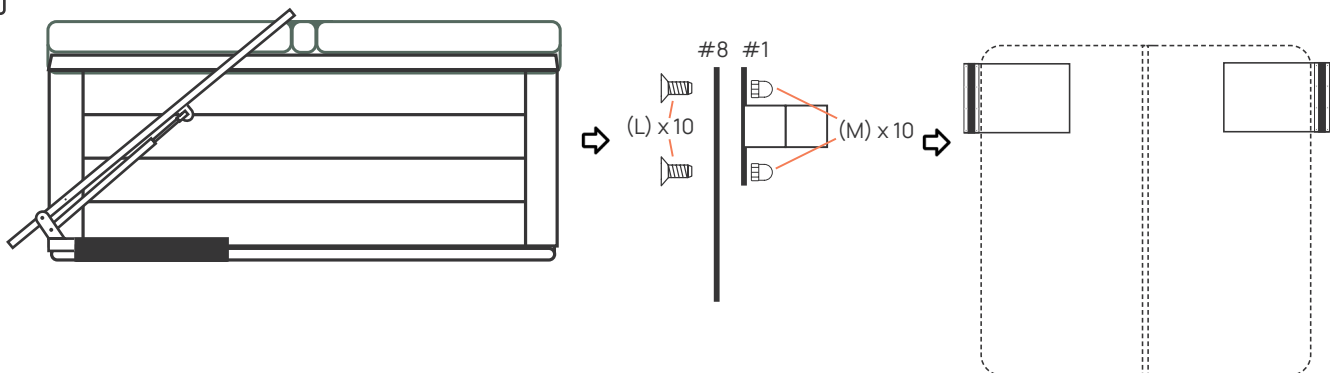

Alternativ 3 - Undermontert

1

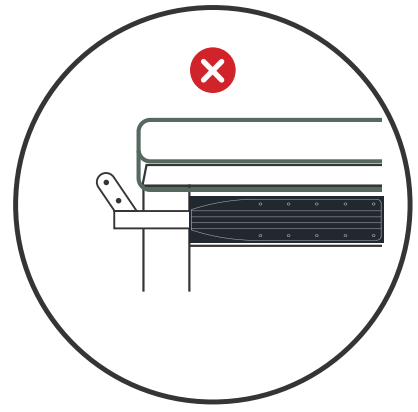
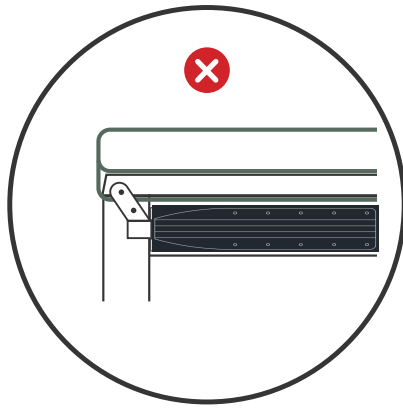
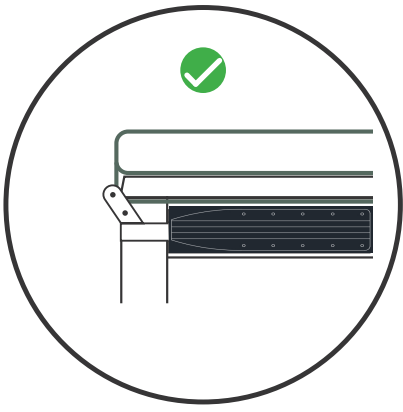



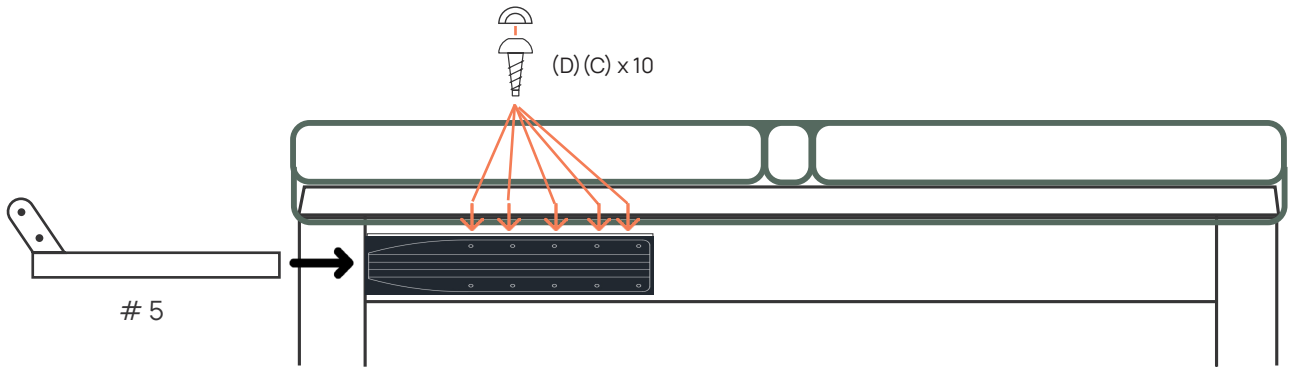

2

-  #5 x 2
-  (D) x 10
-  (C) x 10



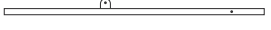



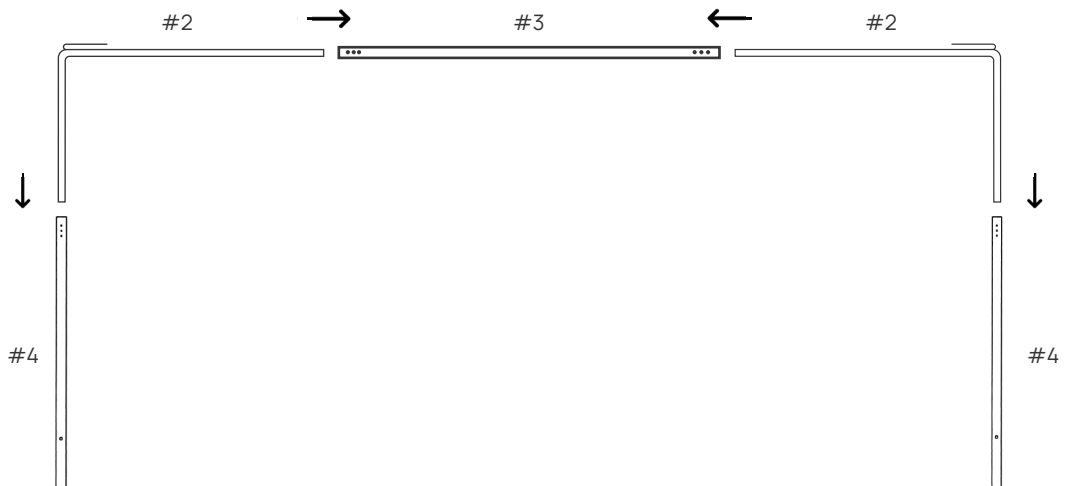

3

-  #4 x 2
-  #3 x 2
-  #2 x 2



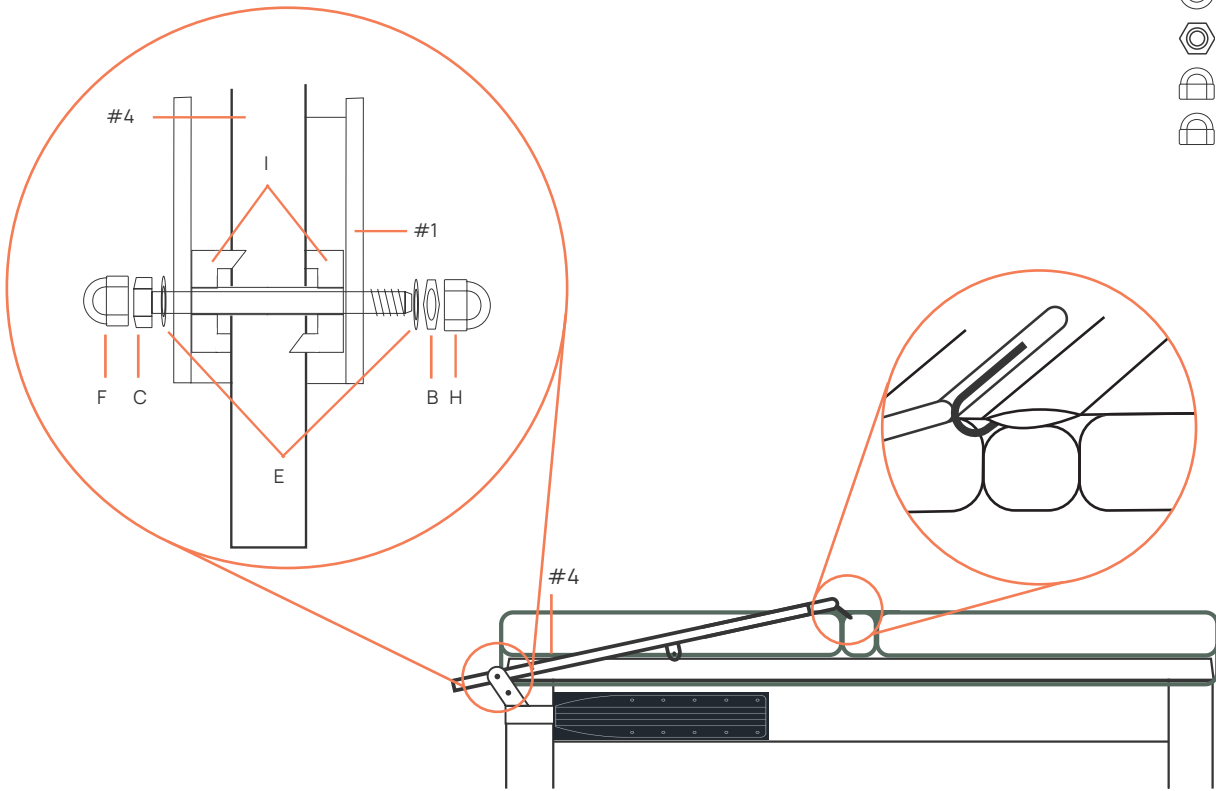

4

-  (I) x 4
-  (C) x 2
-  (E) x 4
-  (B) x 2
-  (H) x 2
-  (F) x 2



5

-  (B) x 12
-  (C) x 12

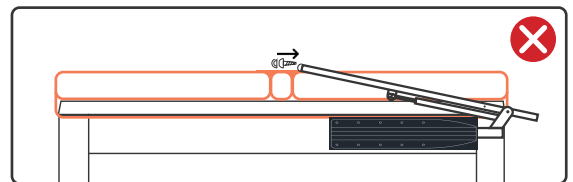
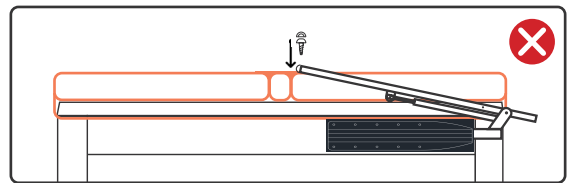
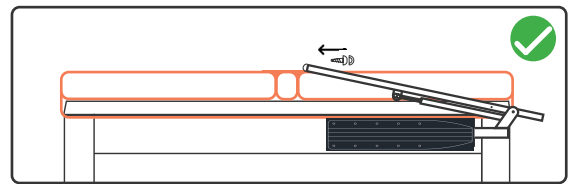
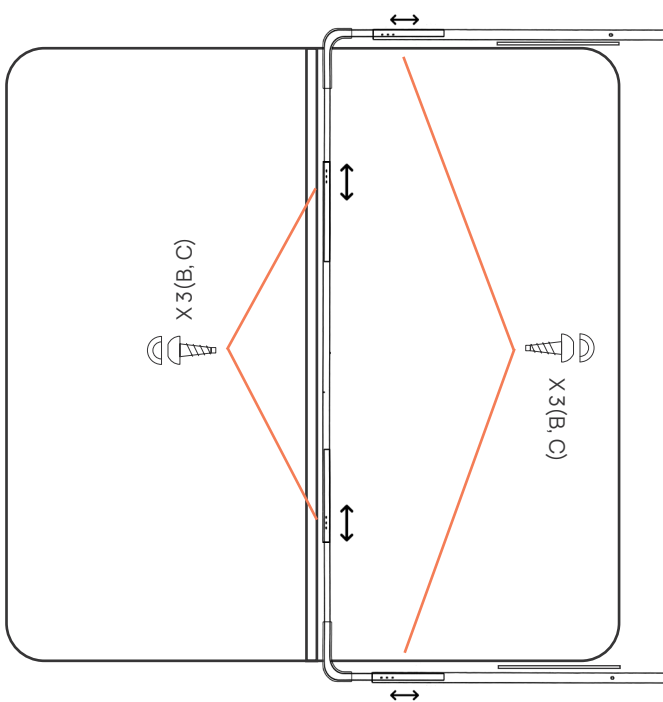

6

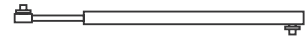

#6 x 2



(K) x 4



(H) x 4

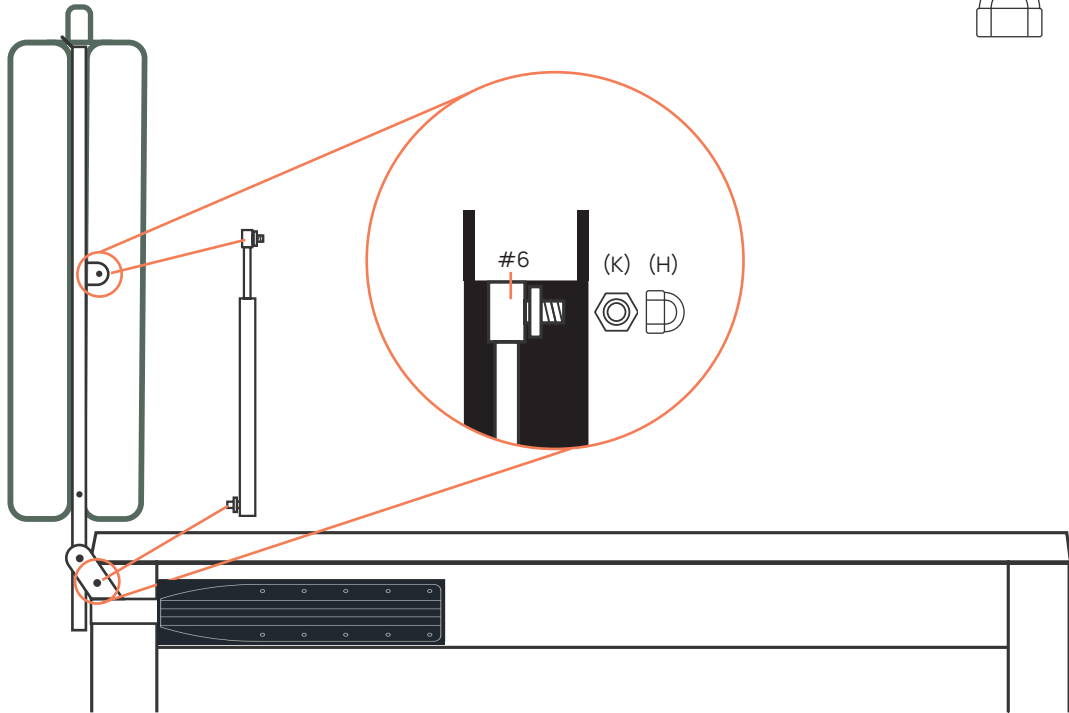

7



#7 x 1



(J) x 1



(N) x 1

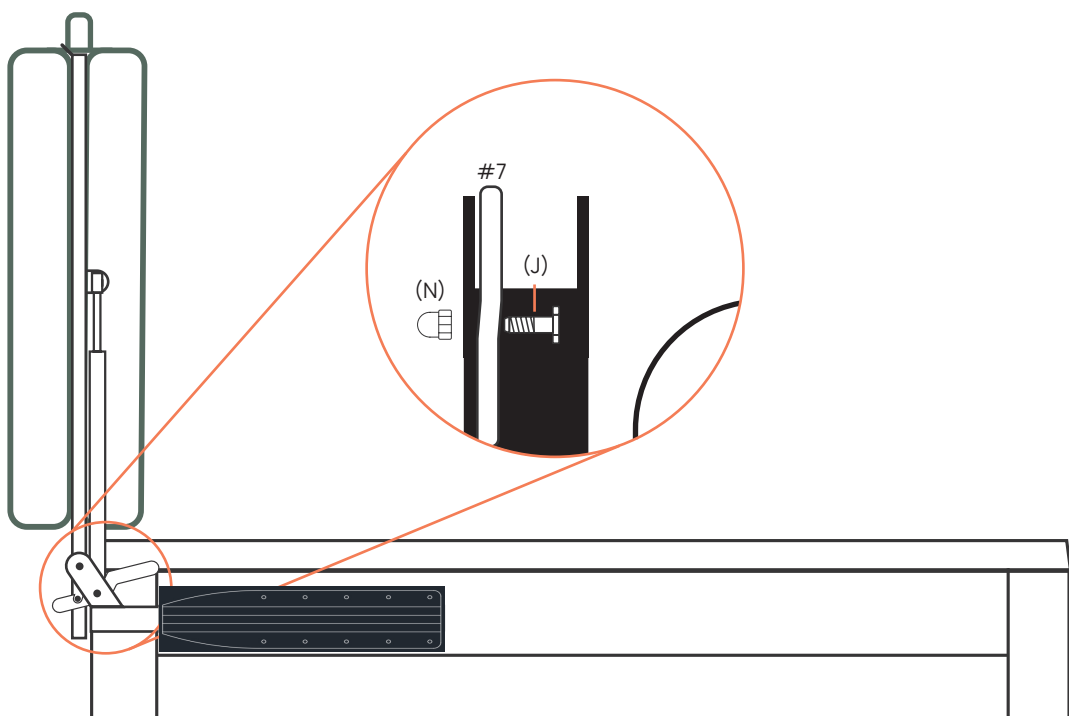

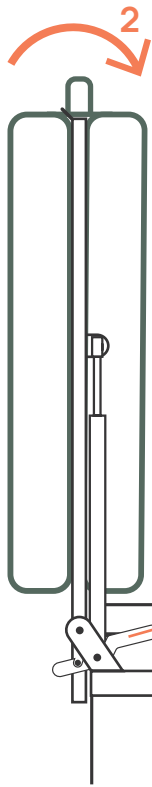

VIKINGBAD

Østerskogen 35,
4879 Grimstad
Tlf: 370 90 600
post@vikingbad.no
vikingbad.no



FORHANDLER:



Sertifikat nr: 3822